

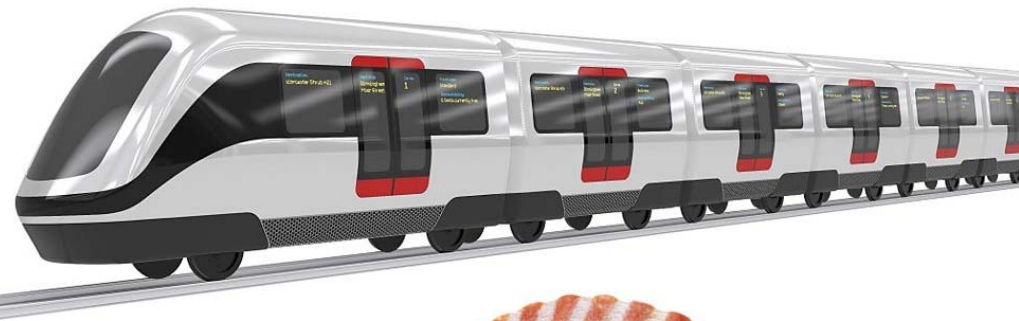

**2023**  
Annual **INCOSE**  
international workshop  
**HYBRID EVENT**  
Torrance, CA, USA  
January 28 - 31, 2023

# MBSE Patterns Working Group

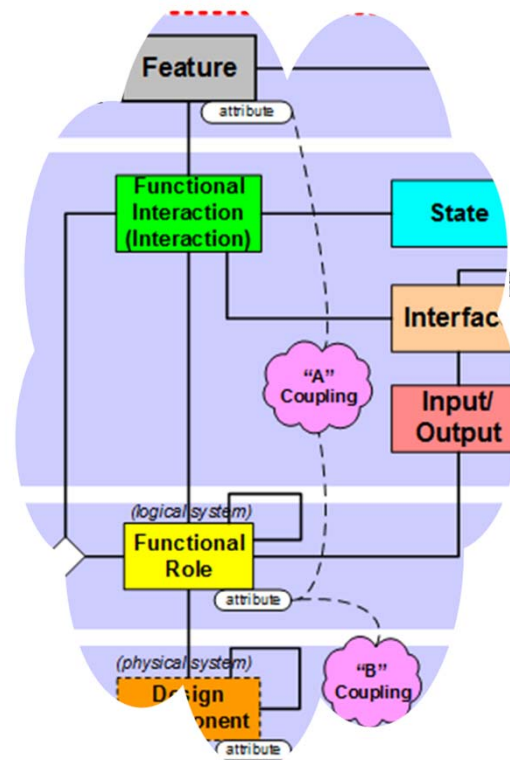

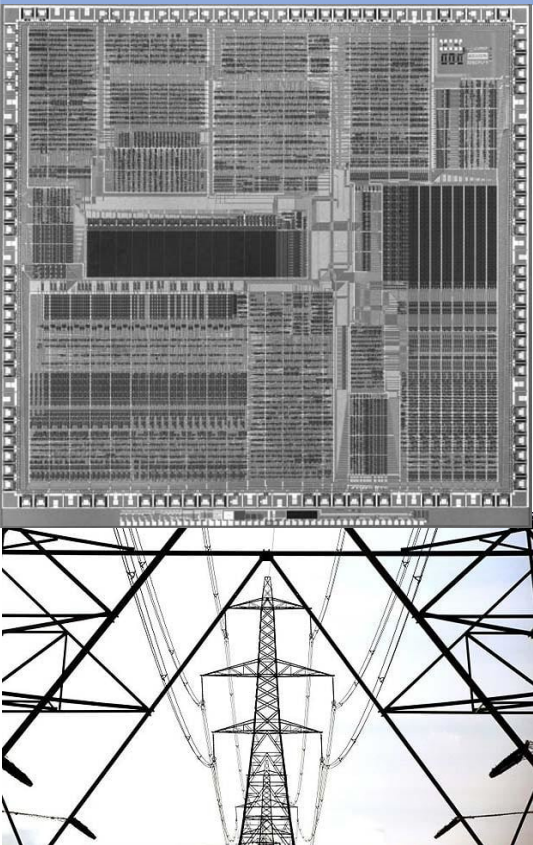

# Agenda Summary

- Welcome and introduction to the MBSE Pattern Working Group's goals and focus
- Introductions and interests of meeting participants
- Overview of MBSE Patterns subject matter and relevance
- Status of current working group projects and activities; related Q&A and interests
- Discussion of additional and future interests of attendees
- Adjourn

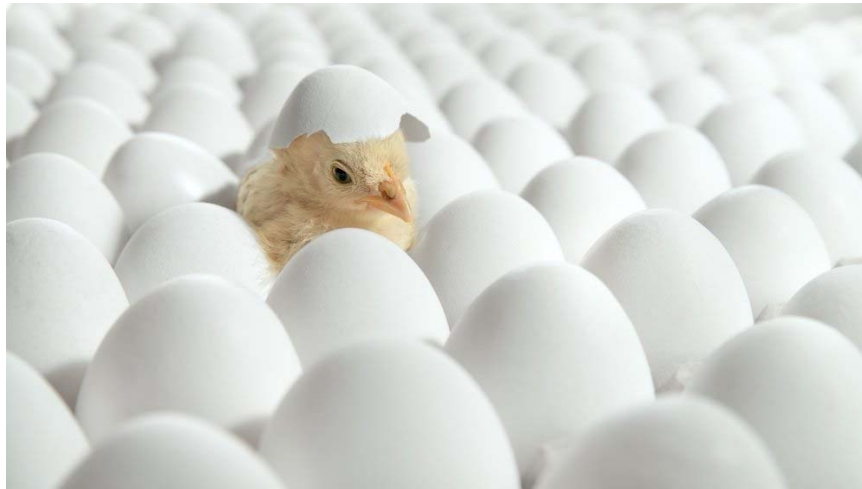

## Began 9.5 years ago, as MBSE Initiative Patterns Challenge Team:

- Part of the joint INCOSE/OMG MBSE Initiative, formed earlier.
- Three years later (2016), our team formally became the INCOSE MBSE Patterns Working Group.
- Because of our MBSE focus, and in order to continue to support the MBSE Initiative, we continue to also be listed as part of that INCOSE/MBSE Initiative.
- *Our working group web site remains part of joint OMG-INCOSE MBSE wiki...*

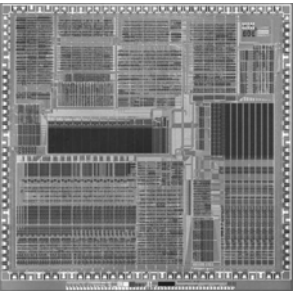

# Focus of MBSE Patterns Working Group: S\*Patterns

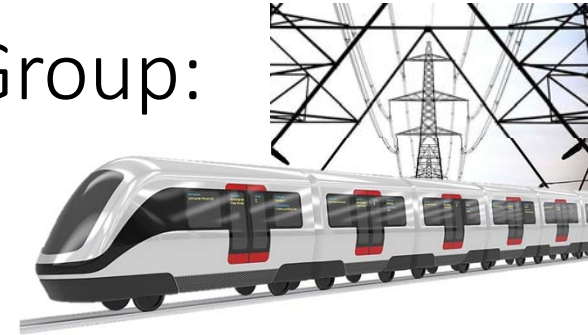

## Configurable, re-usable system models:

1. Models containing a certain minimal set of elements are called S\*Models (S\* is short for “Systematica”).
2. Those underlying elements are called the S\*Metamodel, which was inspired by the unmatched success of the physical sciences and impact of STEM.
3. S\*Models using those elements may be expressed in any modeling language via formal mapping (e.g., in OMG SysML, or in other languages).
4. S\*Models can be (have been) created and managed in many different COTS modeling tools using such diverse languages.
5. Re-usable, configurable S\*Models are called S\*Patterns.
6. By “Pattern-Based Systems Engineering” (PBSE) we mean MBSE enhanced by these generalized assets to enable model configuration from trusted patterns.
7. These are typically system-level patterns (models of whole managed platforms), not just smaller-scale component design patterns.

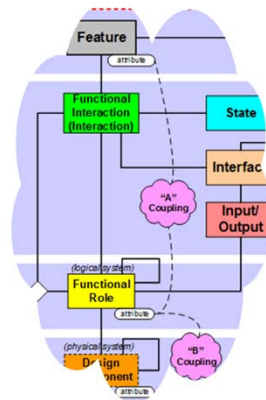

## Patterns--subject matter and relevance

Patterns are . . .

- Recurrences (regularities), across time, locations, projects, products, customers, applications, people, companies, or otherwise;
- the basis of all known laws of the physical sciences for the last 300 years;
- the basis of theoretical foundations of the engineering disciplines;
- the basis of learning, for individuals, groups, and machines;
- the basis of human cognition and reasoning;
- what we did not learn when we repeatedly miss the same opportunities or make the same mistakes again and again;
- why we wake up to a mostly recognizable world each day;
- described by both fixed and variable (parameterized, configured) aspects;
- described informally by natural language;
- described formally by the models of science, engineering, and mathematics;
- not just about engineered products, but also about the methods of engineering, life cycle management, and socio-technical systems in general.

# The INCOSE Patterns Working Group: Who are we?



- Our most active members come from across diverse domains:
  - Automotive
  - Advanced Manufacturing
  - Aerospace
  - Consumer Products
  - Defense
  - Health Care, Medical Devices, Pharmaceuticals
  - Others
- During the last nine years, over 200 colleagues have participated in Patterns Working Group activities:
  - Team meetings, work sessions, tutorials, meetings with other groups.
  - Construction of system patterns.
  - Writing related publications for INCOSE and other technical societies.
  - Invited presentations to INCOSE chapters.

## INCOSE.org MBSE Patterns WG Launch Page:



New (replacement) in 2023!

<https://www.incose.org/incose-member-resources/working-groups/transformational/mbse-patterns>

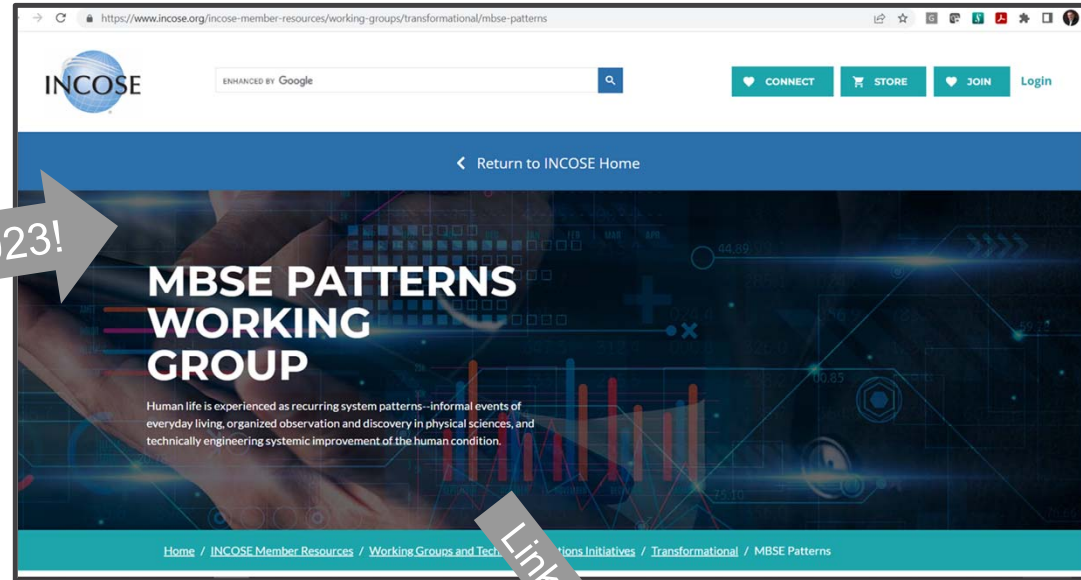

Links to

## INCOSE-OMG MBSE Joint Initiative Web Site for MBSE Patterns WG:



Part of the OMG MBSE Wiki

<https://www.omgwiki.org/MBSE/doku.php?id=mbse:patterns:patterns>







Nine years of meeting materials by Patterns WG and collaborators, by event

**Primary Working Group and Partners Meeting Materials--By Event**

The following table lists chronological meetings, workshops, and other events participated in by the MBSE Patterns Working Group. The links on the right side of the following table link to event-specific minutes, resources, references, and materials:

Event Date	Event Milestone	Status	Point of Contact	Link to Resources
June, 2013	Provide PBSE Tutorial at IS2013	Done	Bill Schindel, Troy Peterson	
Aug. 2013	Gain agreement of MBSE leadership	Done	Bill Schindel, Troy Peterson	
Jul-Aug 2013	Collect initial team members, refine charter	Done	Bill Schindel, Troy Peterson	
Oct. 2013	Provide PBSE Tutorial at GLRC2013	Done	Bill Schindel, Troy Peterson	
Dec. 2013	Challenge team wiki page created	Done	Bill Schindel	
Jan 27, 2014	Challenge team mtg IW2014	Done	Bill Schindel, Troy Peterson	<a href="#">Patterns_Challenge_Team_Mtg_0</a>
June 29-30, 2014	Challenge team mtg IS2014	Done	Bill Schindel, Troy Peterson	<a href="#">Patterns_Challenge_Team_Mtg_0</a>
Aug 12-14, 2014	Challenge team at NDIA GVSETS 2014	Done	Bill Schindel, Troy Peterson	<a href="#">Patterns_Challenge_Team_NDIA_0</a>
Aug 18, 2014	Challenge team mtg	Done	Bill Schindel, Troy Peterson	<a href="#">Patterns_Challenge_Team_Mtg_0</a>
Sep 02, 2014	Challenge team mtg	Done	Bill Schindel, Troy Peterson	<a href="#">Patterns_Challenge_Team_Mtg_0</a>
Sep 15, 2014	Challenge team mtg	Done	Bill Schindel, Troy Peterson	<a href="#">Patterns_Challenge_Team_Mtg_0</a>
Sep 30, 2014	Challenge team mtg	Done	Bill Schindel, Troy Peterson	<a href="#">Patterns_Challenge_Team_Mtg_0</a>
Oct 14, 2014	Challenge team mtg	Done	Bill Schindel, Troy Peterson	<a href="#">Patterns_Challenge_Team_Mtg_1</a>
Oct 28, 2014	Challenge team mtg	Done	Bill Schindel, Troy Peterson	<a href="#">Patterns_Challenge_Team_Mtg_1</a>
Nov 10, 2014	Challenge team mtg	Done	Bill Schindel, Troy Peterson	<a href="#">Patterns_Challenge_Team_Mtg_1</a>
Dec 17, 2014	Challenge team mtg	Done	Bill Schindel, Troy Peterson	<a href="#">Patterns_Challenge_Team_Mtg_1</a>
Jan 12, 2015	Challenge team mtg	Done	Bill Schindel, Troy Peterson	<a href="#">Patterns_Challenge_Team_Mtg_0</a>
Jan 26-27, 2015	Challenge team mtg IW2015	Done	Bill Schindel, Troy Peterson	<a href="#">Patterns_Challenge_Team_Mtg_0</a>
Mar 17, 2015	Challenge team mtg	Done	Bill Schindel, Troy Peterson	<a href="#">Patterns_Challenge_Team_Mtg_0</a>
Apr 21, 2015	Challenge team mtg	Done	Bill Schindel, Troy Peterson	<a href="#">Patterns_Challenge_Team_Mtg_0</a>
May 19, 2015	Challenge team mtg	Done	Bill Schindel, Troy Peterson	<a href="#">Patterns_Challenge_Team_Mtg_0</a>
June 16, 2015	Challenge team mtg	Done	Bill Schindel, Troy Peterson	<a href="#">Patterns_Challenge_Team_Mtg_0</a>
June 14, 2015	ASCE System Competencies Workshop	Done	Mario Simoni	<a href="#">ASCE_2015_Systems_Competen</a>
July 12-13, 2015	Challenge team mtg IS2015	Done	Bill Schindel, Troy Peterson	<a href="#">Patterns_Challenge_Team_Mtg_0</a>
Jan 12, 2015	Patterns WG mtg	Done	Bill Schindel, Troy Peterson	<a href="#">Patterns_Challenge_Team_Mtg_0</a>
Jan 30-31, 2016	Patterns WG mtg IW2016	Done	Bill Schindel, Troy Peterson	<a href="#">Patterns_Challenge_Team_Mtg_0</a>
May 24-25, 2016	MBSE Patterns WG Participation in INCOSE Agile Health Care Systems Conference	Done	Bill Schindel, Troy Peterson	<a href="#">MBSE_Patterns_WG_Participation</a>
July 5, 2016	MBSE Patterns WG mtg	Done	Bill Schindel, Troy Peterson	<a href="#">MBSE_Patterns_WG_Mtg_07.05.1</a>
July 17, 2016	MBSE Patterns WG mtg IS2016	Done	Bill Schindel, Troy Peterson	<a href="#">MBSE_Patterns_WG_Team_Mtg_1</a>
July 28, 2016	MBSE Patterns WG Participation in ISSS2016	Done	Bill Schindel	<a href="#">MBSE_Patterns_WG_Participation</a>
Sept 19-21, 2016	MBSE Patterns WG Participation in GLRC2016	Done	Bill Schindel	<a href="#">MBSE_Patterns_WG_Participation</a>
Nov 7-8, 2016	MBSE Patterns WG in ASME W50 Cmtee on V&V of Models, Schenectady, NY	Done	Bill Schindel	<a href="#">MBSE_Patterns_WG_Participation</a>
Nov 28-29, 2016	MBSE Patterns WG Partic in INCOSE/IEEE EnergyTech 2016, Cleveland	Done	Bill Schindel	<a href="#">MBSE_Patterns_WG_Participation</a>
Jan 28-31, 2017	MBSE Patterns WG Mtgs at IW2017	Done	Bill Schindel, Troy Peterson	<a href="#">Patterns_Challenge_Team_Mtg_0</a>
April 12, 2017	MBSE Patterns WG Participation in INCOSE Enchantment Chapter Meeting (New Mexico)	Done	Bill Schindel	<a href="#">Patterns_WG_Participation</a>
May 2-5, 2017	MBSE Patterns WG Participation in ASME Model V&V Symposium, Las Vegas	Done	Bill Schindel	<a href="#">Patterns_WG_Participation_ASME_Mod</a>
May 16-17, 2017	MBSE Patterns WG Participation in INCOSE Agile Health Care Systems Conf, Chicago	Done	Bill Schindel	<a href="#">Patterns_WG_Participation_INCOSE_Ag</a>
May 21-24, 2017	MBSE Patterns WG Participation in No Magic MBSE Symposium, Allen, TX	Done	Bill Schindel	<a href="#">Patterns_WG_Participation_No_Magic_1</a>
June 5-9, 2017	MBSE Patterns WG Partic in AIAA Aviation 2017, Denver	Done	Bill Schindel, Troy Peterson	<a href="#">MBSE_Patterns_WG_Participation_A</a>
July 15-17, 2017	MBSE Patterns WG Meetings at IS2017	Done	Bill Schindel, Troy Peterson	<a href="#">Patterns_Challenge_Team_Mtg_0</a>

On main web site

June 5-9, 2017	MBSE Patterns WG Partic in AIAA Aviation 2017, Denver	Done	Bill Schindel, Troy Peterson	<a href="#">MBSE_Patterns_WG_Participation_A</a>
July 15-17, 2017	MBSE Patterns WG Meetings at IS2017	Done	Bill Schindel, Troy Peterson	<a href="#">Patterns_Challenge_Team_Mtg_0</a>
	ikes Conference GLRC11	Done	Bill Schindel	<a href="#">GLRC11_10.12.17</a>
	IG Partic in ISA EnergyTech 2017,	Done	Bill Schindel	<a href="#">MBSE_Patterns_WG_Participation</a>
Jan 20-23, 2018	MBSE Patterns WG Partic in INCOSE IW2108 Jacksonville, FL	Done	Bill Schindel	<a href="#">MBSE_Patterns_WG_Participation</a>
April, 2018	MBSE Patterns WG Partic in IFSR Conversation 2018, Linz, Austria	Done	Bill Schindel	<a href="#">MBSE_Patterns_WG_Participation</a>
May, 2018	MBSE Patterns WG Partic in INCOSE 2018 Health Care Systems Conference, Minneapolis, MN	Done	Bill Schindel	<a href="#">MBSE_Patterns_WG_Participation_Conference_2018</a>
May, 2018	MBSE Patterns WG Partic in Aerospace Corporation SE Forum, Chantilly, VA	Done	Bill Schindel	<a href="#">MBSE_Patterns_WG_Participation_2018</a>
July, 2018	MBSE Patterns WG Partic in INCOSE IS2018 Washington, DC	Done	Bill Schindel	<a href="#">MBSE_Patterns_WG_Participation</a>
July, 2018	MBSE Patterns WG Partic in ISSS2018 Corvallis, OR	Done	Bill Schindel	<a href="#">MBSE_Patterns_WG_Participation</a>
Oct. 2018	MBSE Patterns WG Partic in SAE 2018 Standards Summit, Tyson's Corner, VA	Done	Bill Schindel	<a href="#">MBSE_Patterns_WG_Participation</a>
Oct. 2018	MBSE Patterns WG Partic in INCOSE GLRC 2018 Indianapolis, IN	Done	Bill Schindel	<a href="#">MBSE_Patterns_WG_Participation</a>
Oct. 2018	MBSE Patterns WG Partic in FDA PBSE Seminar, Washington DC	Done	Bill Schindel	<a href="#">MBSE_Patterns_WG_Participation</a>
Jan, 2019	MBSE Patterns WG Partic in INCOSE IW2019, Torrance, CA	Done	Bill Schindel	<a href="#">MBSE_Patterns_WG_Participation</a>
May, 2019	MBSE Patterns WG Partic in ASME Model V&V 2019 Symposium, Las Vegas, NV	Done	Bill Schindel	<a href="#">MBSE_Patterns_WG_Participation</a>
May, 2019	Model Characterization Pattern Workshop Prep, Indianapolis, IN	Done	Bill Schindel	<a href="#">Model_Characterization_Pattern_1</a>
July, 2019	MBSE Patterns WG Partic in INCOSE IS2019, Orlando, FL	Done	Bill Schindel	<a href="#">MBSE_Patterns_WG_Participation</a>
Oct. 2019	MBSE Patterns WG Partic in ASSESS 2019, Atlanta, GA	Done	Bill Schindel	<a href="#">MBSE_Patterns_WG_Participation</a>
January, 2020	MBSE Patterns WG Partic in INCOSE IW2020, Torrance, CA	Done	Bill Schindel	<a href="#">MBSE_Patterns_WG_Participation</a>
January, 2021	MBSE Patterns WG Partic in INCOSE IW2021 Virtual Sessions	Done	Bill Schindel	<a href="#">MBSE_Patterns_WG_Participation</a>
April, 2021	MBSE_Patterns_WG_Participation_In_ASME MBSE Sids Cmtee Spring 2021 Mtgs	Done	Bill Schindel	<a href="#">MBSE_Patterns_WG_Participation_Mtgs</a>
May, 2021	MBSE_Patterns_WG_Participation_In_ASME Model V&V 2021 Symposium	Done	Bill Schindel	<a href="#">MBSE_Patterns_WG_Participation</a>
April, 2021	MBSE_Patterns_WG_Participation_In_Big Lever Momentum 2021 Conference	Done	Bill Schindel	<a href="#">MBSE_Patterns_WG_Participation</a>
June, 2021	MBSE_Patterns_WG_Participation_In Indiana Digital Thread Technical Exchange Meeting	Done	Bill Schindel	<a href="#">MBSE_Patterns_WG_Participation_Exchange_Meeting</a>
December, 2021	INCOSE_North_Texas_Chapter_Program	Done	Bill Schindel	<a href="#">MBSE_Patterns_WG_Participation_I_Program</a>
January, 2022	AIAA_SCITECH2022	Done	John Matlik	<a href="#">MBSE_Patterns_WG_Support_for_AI</a>
January, 2022	INCOSE_IW2022	Done	Bill Schindel, Troy Peterson	<a href="#">MBSE_Patterns_WG_Participation_I</a>
June, 2022	INCOSE North TX Chapter Pgm	Done	Bill Schindel	<a href="#">MBSE_Patterns_WG_Participation_I</a>
June, 2022	INCOSE_IS2022	Done	Bill Schindel	<a href="#">MBSE_Patterns_WG_Participation_I</a>
June, 2022	AIAA AVIATION 2022	Done	Bill Schindel	<a href="#">MBSE_Patterns_WG_Participation_I</a>
Jan, 2023	INCOSE IW 2023	Pending	Bill Schindel, Troy Peterson	<a href="#">MBSE_Patterns_WG_Participation_I</a>

On main web site

## Project Working Pages

[Interface\\_Patterns\\_Team](#)

[Innovation\\_Collaboration\\_Ecology\\_Project\\_with\\_TIMLM\\_WG\\_and\\_PLE\\_WG](#)

[Legacy\\_Product\\_Line\\_Pattern\\_Extraction\\_Project\\_with\\_PLE\\_WG](#)

[Patterns\\_In\\_Systems\\_Of\\_Systems\\_Project\\_with\\_SoS\\_WG](#)

[MBSE\\_Transformation\\_Adoption\\_Pattern\\_Project](#)

[Critical\\_Infrastructure\\_Protection\\_and\\_Recovery\\_Patterns\\_Project\\_with\\_CIPR\\_WG](#)

[Health\\_Care\\_Domain\\_Patterns\\_Project\\_with\\_HC\\_WG](#)

[Verification\\_&\\_Validation\\_of\\_Models\\_Project\\_with\\_ASME\\_Std\\_Cmtee](#)

[Agile\\_Systems\\_Engineering\\_Life\\_Cycle\\_Management\\_\(ASELCM\)\\_Discovery\\_Project\\_with\\_ASE\\_WG](#)

[Foundations\\_of\\_Systems\\_Science\\_and\\_Engineering\\_Project\\_with\\_SSWG](#)

[Semantic\\_Patterns\\_and\\_Technologies\\_for\\_Systems\\_Engineering\\_Project](#)

[Vision\\_2035\\_Support](#)

[S\\*Models Primer Project](#)

[S\\*Patterns Primer Project](#)

- INCOSE is also *just starting* to make use of “Yammer”, another form of social media in the new INCOSE IT ecosystem.
- The MBSE Patterns WG has a Yammer Community getting started, but we are not nearly as far along with this as the other Patterns WG web resources above.
- You are welcome to join this community, but please contribute and be patient as we learn to make good use of it!

## Yammer

The screenshot shows the Yammer interface for the MBSE Patterns Working Group. The page features a header with the group name and a 'Joined' button. Below the header is a navigation bar with 'Conversations', 'About', 'Files', and 'Events'. The main content area includes a post prompt 'Share thoughts, ideas, or updates' and options for 'Discussion', 'Question', 'Praise', and 'Poll'. The right sidebar displays 'Members • 202' with a list of member avatars and a 'Mission' section describing the group's purpose: 'The mission of the INCOSE MBSE Patterns Working Group is to advance the availability and awareness of systems engineering practices and resources for impactful creation, application, and ongoing improvement of recurring model-based patterns over system life cycles. We were established as, and remain a part of, the Joint INCOSE-OMG MBSE Initiative. Most of our work is carried out in partnership with other INCOSE Working Groups and other technical or professional societies.'



# How to get involved with Patterns WG

- If you'd like to participate in, or follow, a current WG project, . . .
- If you would like to suggest a new WG project, . . .

## Contact:

WG chair: Bill Schindel [schindel@icctt.com](mailto:schindel@icctt.com)

WG co-chair: Troy Peterson [tpeterson@systemxi.com](mailto:tpeterson@systemxi.com)

- Based on the newest INCOSE information systems, you should especially add to your INCOSE Member Profile (at [incose.org](http://incose.org)) that you want to be affiliated with this WG.

# Membership in the MBSE Patterns WG:

## Help us respond to your interest and engage!



- Anyone interested is welcome, but this WG is especially for INCOSE members.
- Over the years, how we track our WG's membership list and perform communications has been challenging, as INCOSE technical systems and even legal constraints have evolved.
- We are learning that the best way for you to get formally listed as a member of the WG and into our WG mail list is to indicate in your INCOSE Member Profile ([www.incose.org](http://www.incose.org)) that you are affiliated with this WG.
- Sincere apologies to anyone we have missed in the past—please let us know and be sure to register your interest in this WG in your INCOSE Member Profile.

Nearly all our work includes partner INCOSE WGs or others

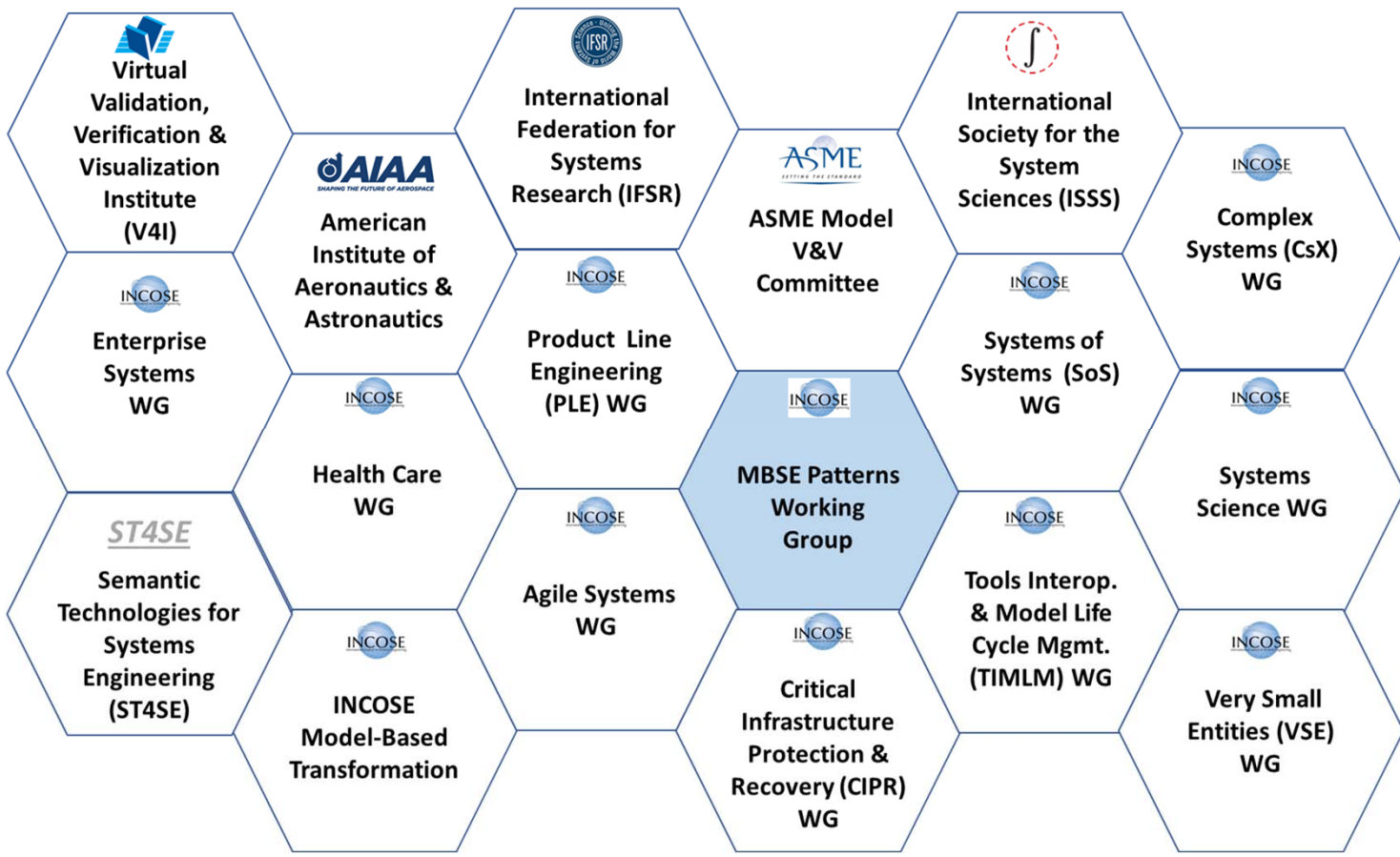

Participate! Collaborate!

# Participant introductions and interests

*If today's meeting is not too large . . .*

- Please introduce yourself
- Tell us about your interests in this meeting and its subjects
- 
- 
- 
-

# An “MBSE Patterns 101” Introduction

We’ll look at a small sample of theory & practice for the next few minutes:

- A key point is realizing patterns suggest we *strengthen underlying MBSE representation*.

For a more complete look, see:

- PBSE Methods and Position in Related Subjects

[https://www.omgwiki.org/MBSE/lib/exe/fetch.php?media=mbse:patterns:pbse\\_extension\\_of\\_mbse--methodology\\_summary\\_v1.6.1.pdf](https://www.omgwiki.org/MBSE/lib/exe/fetch.php?media=mbse:patterns:pbse_extension_of_mbse--methodology_summary_v1.6.1.pdf)

- MBSE Patterns Tutorial

[http://www.omgwiki.org/MBSE/lib/exe/fetch.php?media=mbse:patterns:pbse\\_tutorial\\_glr\\_c\\_2016\\_v1.7.4.pdf](http://www.omgwiki.org/MBSE/lib/exe/fetch.php?media=mbse:patterns:pbse_tutorial_glr_c_2016_v1.7.4.pdf)

- Simple Content Example: Oil Filter System

[https://www.omgwiki.org/MBSE/lib/exe/fetch.php?media=mbse:patterns:oil\\_filter\\_example\\_v1.6.2.pdf](https://www.omgwiki.org/MBSE/lib/exe/fetch.php?media=mbse:patterns:oil_filter_example_v1.6.2.pdf)

- Patterns WG web site:

<http://www.omgwiki.org/MBSE/doku.php?id=mbse:patterns:patterns>



# Formalizing System Terms and Representations

- Definition: *In the perspective described here\**, by “System” we mean a collection of interacting system components:

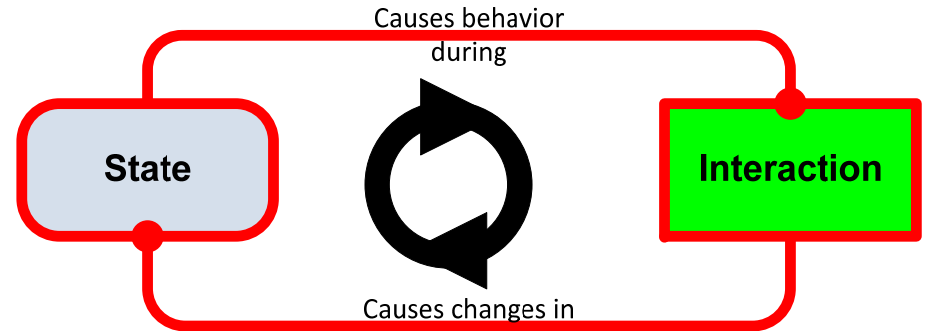
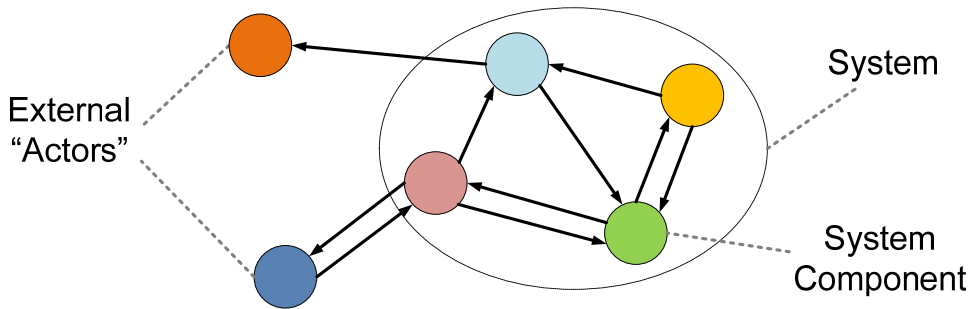

- By “interacting” we mean the exchange of energy, force, material, or information (all of these are “input-outputs”) between system components, . . .
- . . . through which one component impacts the state of another component.
- By “state” we mean a property of a component that impacts its input-output behavior during interactions. (Note the circular cause-effect definition chain here.)
- So, a component’s “behavior model” describes input-output-state relationships during interaction—*there is no “naked behavior” in the absence of interaction.*
- The behavior of a system involves emergent *states of the system as a whole*, exhibited in its behavior during its own external interactions, resulting in observable holistic aspects.

(\* Other world view definitions of “System” are acknowledged; there are reasons for our minimalist choice of definitions.)

# S\* Models

- An S\* Model is any model (descriptive information construct) of a system, in any language, view, or tooling, which can be semantically mapped to the S\*Metamodel (e.g., SysML, etc.):

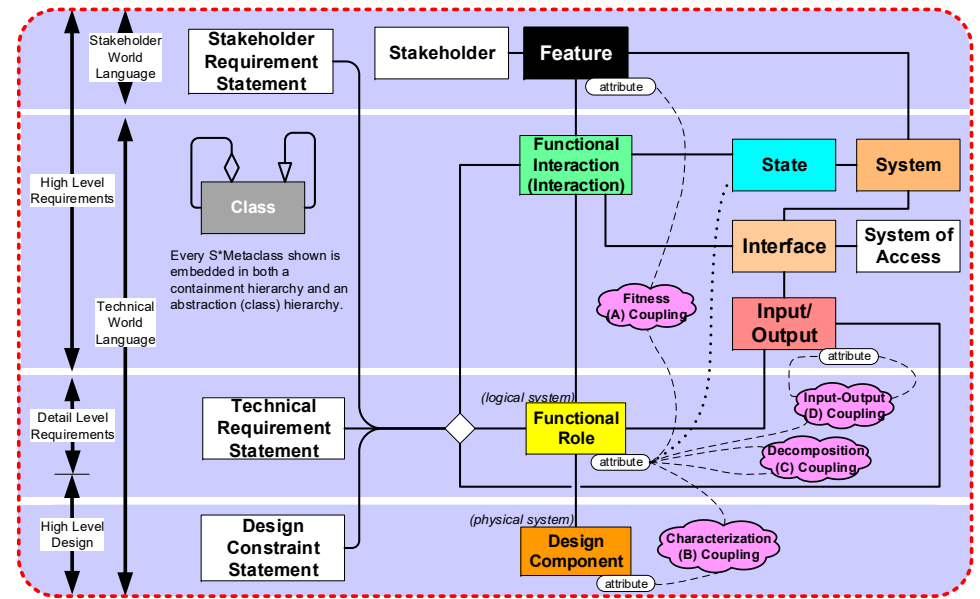
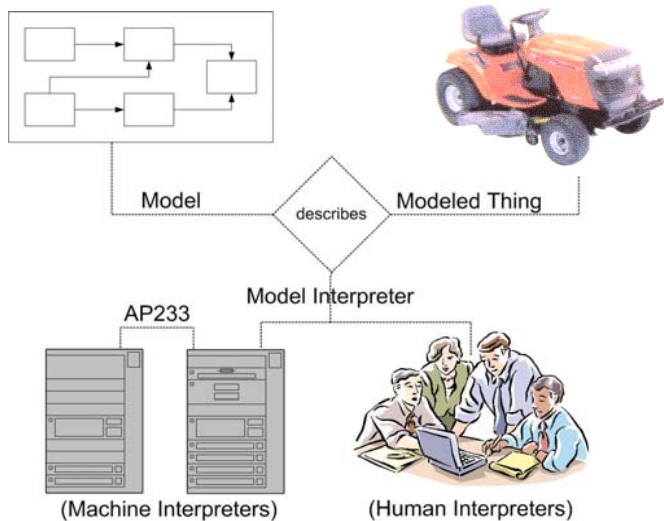

**S\*Metamodel informal summary pedagogical diagram**  
(formal S\*Metamodel includes additional details.)

So what is the S\*Metamodel, and more important why is it?

# S\*Metamodel: A reference model of models

- The S\*Metamodel is intended to answer:
  - What is the smallest amount of information necessary to describe a system over its life cycle, for the purposes of science and engineering?
- Important because contemporary MBSE models often:
  - Are missing key aspects (are too small)
  - Contain redundant conflicting aspects (are too big)
  - At the same time!
  - We will be discussing prominent examples of both.
- This session will briefly refer to the “informal pedagogical” S\*Metamodel diagram above, as a partial intuitive guide.
- Backed by the formal S\*Metamodel (~100 pages of UML and prose), to understand its formal mapping to modeling languages like OMG SysML, third party modeling tools, etc.)
- Not an alternative modeling language or tool!

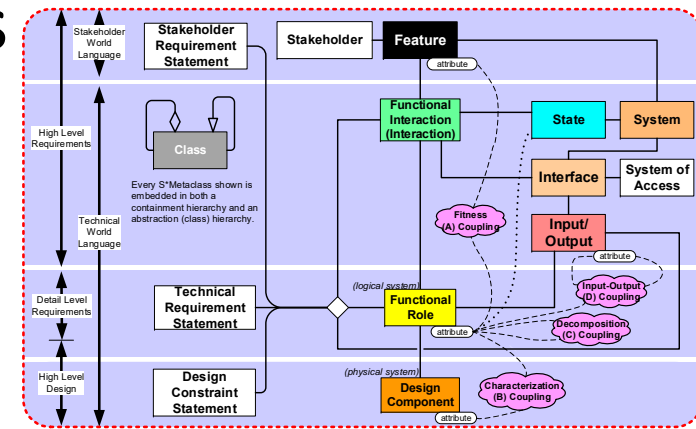

Informal pedagogical S\*Metamodel subset diagram

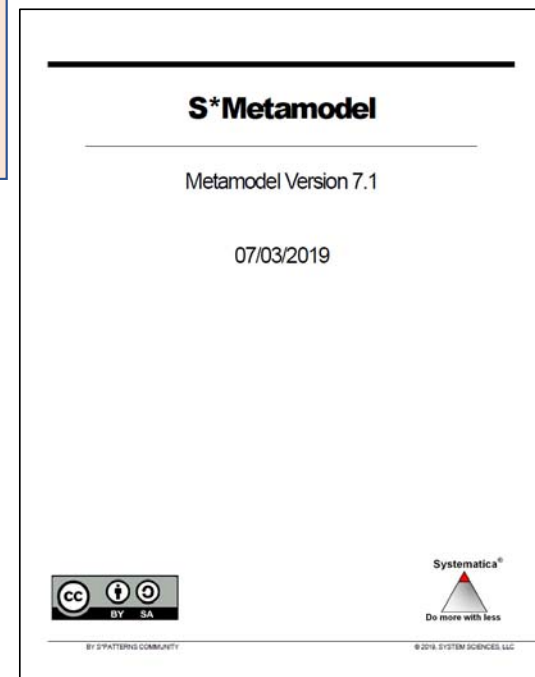

Formal S\*Metamodel (~100 pages UML & prose)

# Existing mappings into OMG SysML, other languages, and your tooling

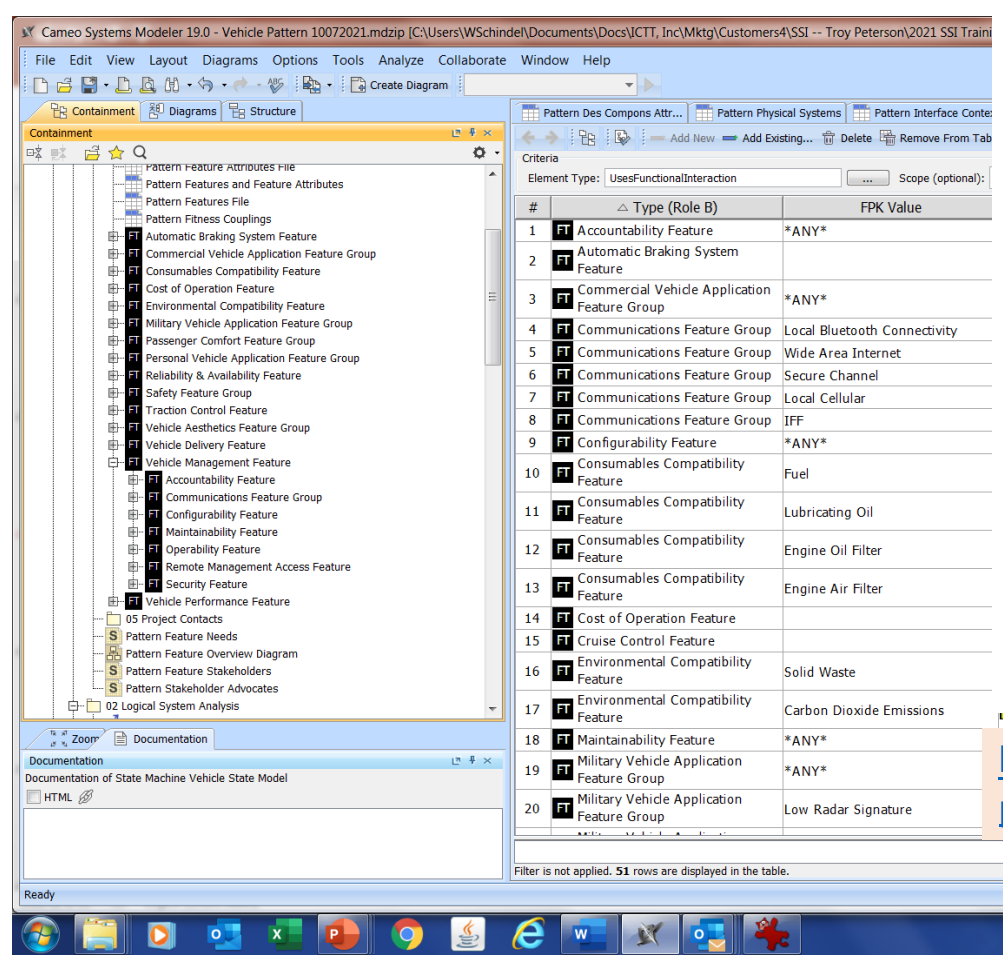

Using **OMG SysML™**  
With  
**Systematica™ Methodology Release 4.0**

**Mapping Guide**

Configured for:  
**Sparx Systems Enterprise Archi**

Version 1.5  
November 22, 2019

By: S\* Patterns Community

**S\*Metamodel Mapping**  
for  
**MagicDraw/Cameo Systems Modeler**  
Version 19

**S\*Metamodel Mapping**  
for  
**OMG SysML®**

Version 2.1.3  
10/11/2018

[https://www.omgwiki.org/MBSE/lib/exe/fetch.php?media=mbse:patterns:systematica\\_mapping\\_for\\_magicdraw\\_csm\\_v1.9.1a.pdf](https://www.omgwiki.org/MBSE/lib/exe/fetch.php?media=mbse:patterns:systematica_mapping_for_magicdraw_csm_v1.9.1a.pdf)

By: S\*Patterns Community

© 2018, System Sciences, LLC

# Domain Model: One important system model view

- All the external actors with which a system of interest interacts directly, forming a “Domain System”.
- The (larger) system that is the context of the System of Interest.
- Domain Patterns provide powerful introductions to the context of different system products, markets, and applications, such as:
  - Aerospace
  - Automotive
  - Medical Devices
  - Consumer Products
  - Telecommunications
  - Manufacturing
- Example Domain Systems:
  - Total life cycle domain
  - Operational or In-Service Domain
  - Maintenance or Sustainment Domain
  - Distribution Domain

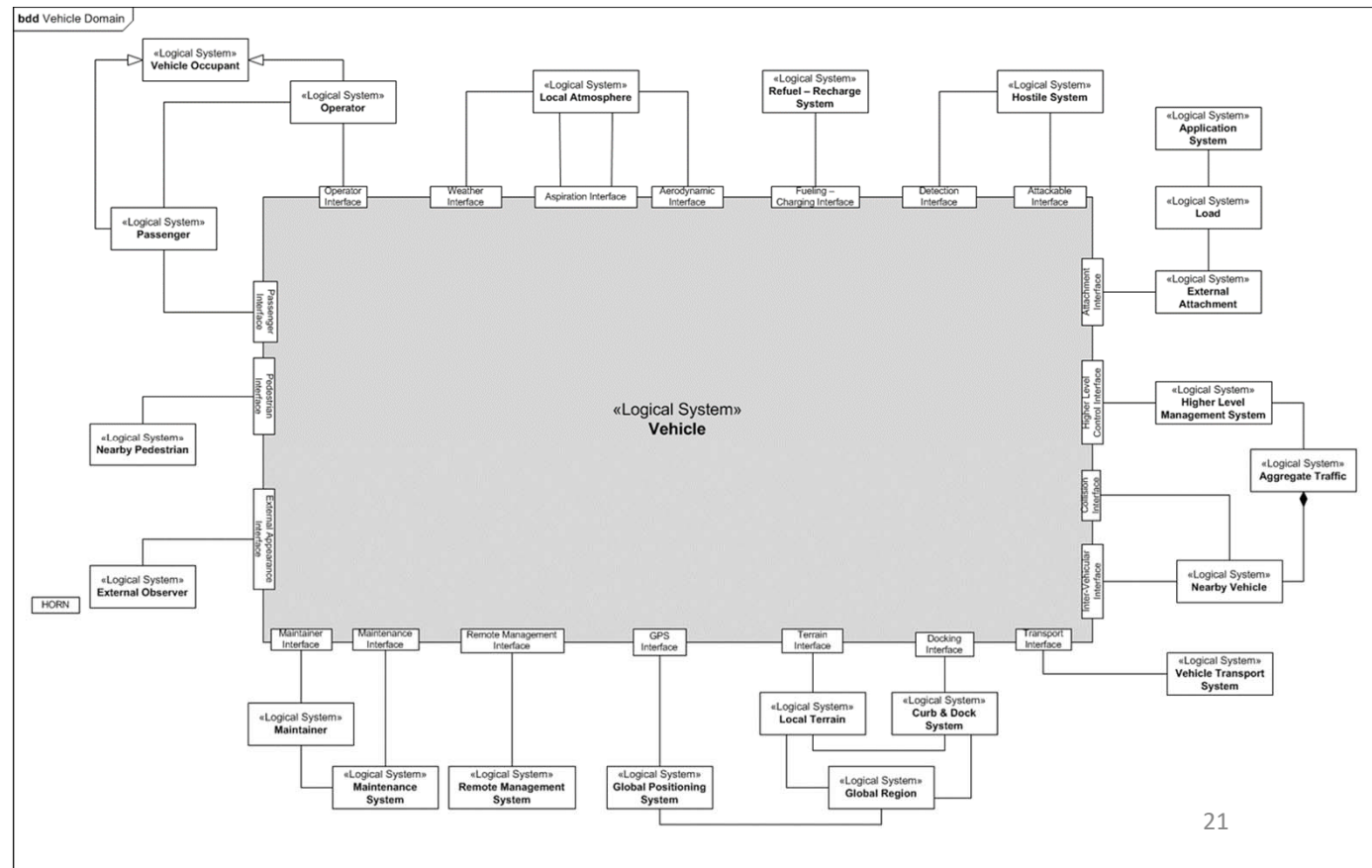

# Functional Interactions: Phenomena; clarifying SE views of behavior

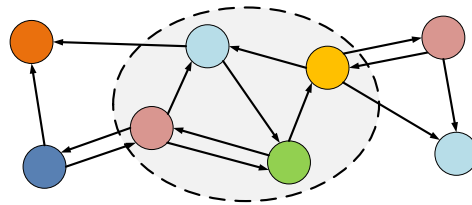

- A Functional Interaction (or simply, an Interaction) is an exchange of Input-Outputs (energy, force, material, information) between two or more system components, resulting in component changes of state.
- Two such components might be within a product you are designing—but they also might be that product (viewed as a “black box”) and actors in its external environment, in which case the overall system is the Domain System.
- By “state” we mean a property of a component that impacts its input-output behavior during interactions. (Note the circular cause-effect definition chain here.)
- So, a component’s “behavior model” describes input-output-state relationships during interaction—*there is no “naked behavior” in the absence of interaction.*
- Interactions are not an important “side issue”—they are at the heart of engineering and science:
  - All the known physical laws of the hard sciences are about or in the context of interactions.
- It will turn out to be very important to identify “all” the interactions—a subject to which we’ll return.

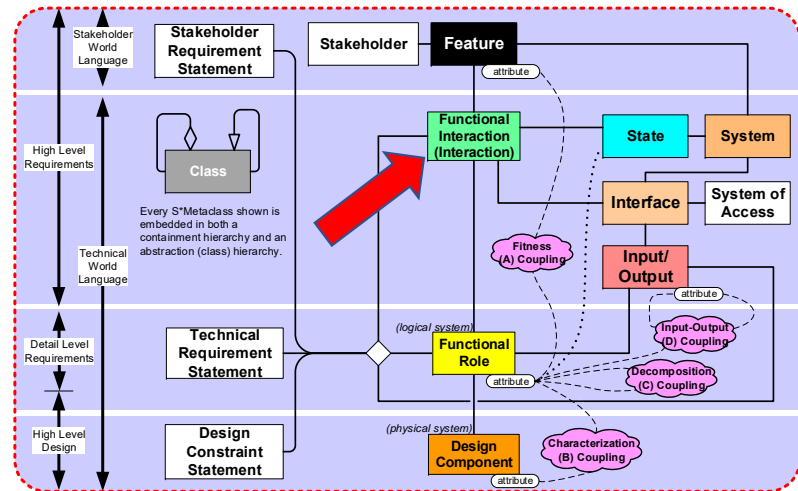

S\*Metamodel informal summary pedagogical diagram  
(formal S\*Metamodel includes additional details.)

**System Interactions**  
Making the Heart of Systems More Visible  
William D. Schindel  
ICTT System Sciences schindel@ictt.com

INCOSE GLRC 2013: Leadership Through Systems Engineering  
Copyright © 2013 by William D. Schindel. Permission granted to INCOSE to publish and use. 1.2.2

[https://www.omgwiki.org/MBSE/lib/exe/fetch.php?media=mbse:patterns:system\\_interactions--making\\_the\\_heart\\_of\\_systems\\_more\\_visible\\_v1.2.2.pdf](https://www.omgwiki.org/MBSE/lib/exe/fetch.php?media=mbse:patterns:system_interactions--making_the_heart_of_systems_more_visible_v1.2.2.pdf)

# Interactions: Vehicle example

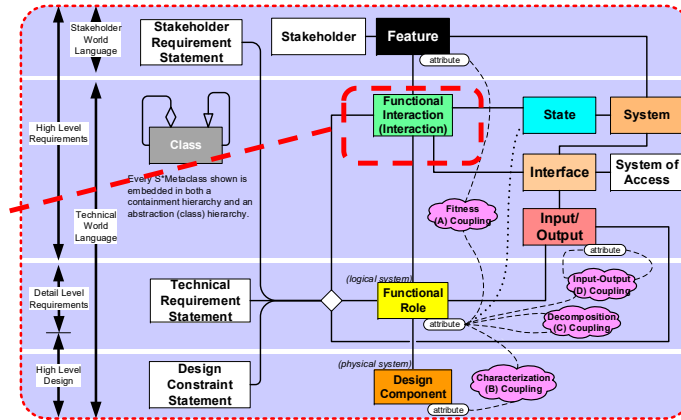
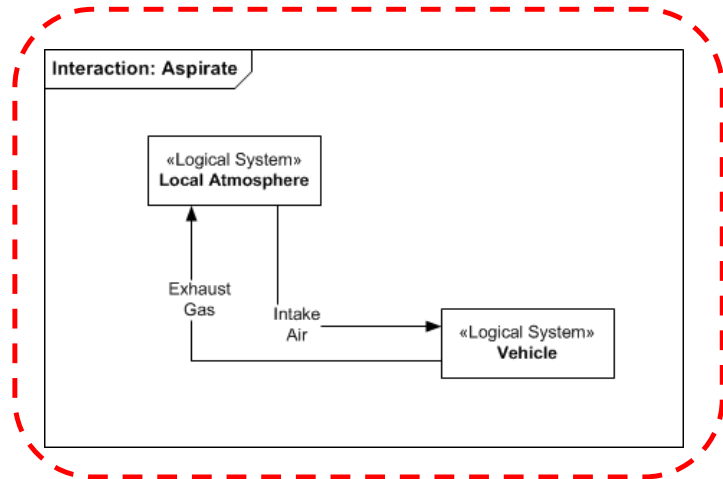

S\*Metamodel informal summary pedagogical diagram  
(formal S\*Metamodel includes additional details.)

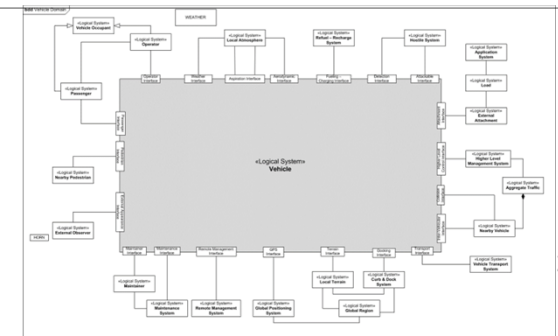
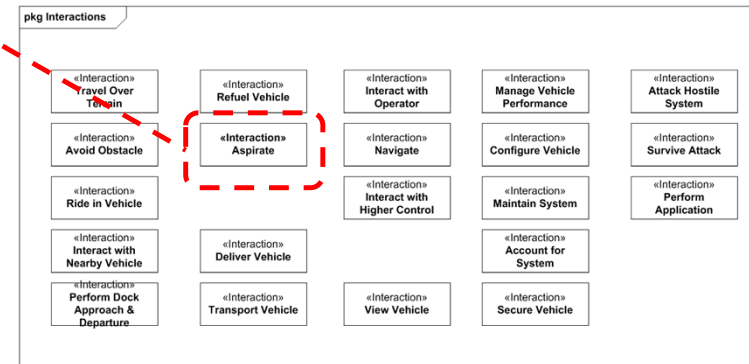

- A key point for systems engineers is not to over-emphasize “my system” as opposed to its interactions with external actors.
- Sometimes engineers object that “I am not responsible for and cannot control those other actors”; however, . . .
- The fact is, the only externally visible behaviors your product will exhibit are its interactions with those external actors.
- The technical requirement specifications for your product are all manifest in its interactions with external actors.
- You do not have to design or control those external actors, but you do have to understand their behaviors in interaction with your product.
- Interactions are shown as diverse types of model and tabular diagrams and views: Collaboration Diagrams, Sequence/Timing Diagrams, FFBDs, Free Body Diagrams, etc.

# Dual Hierarchies: There are containment and class hierarchies of logical systems, as well as other classes

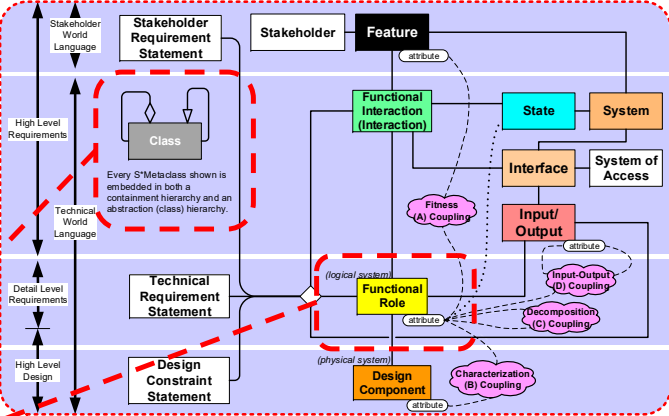

S\*Metamodel informal summary pedagogical diagram (formal S\*Metamodel includes additional details.)

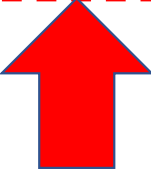
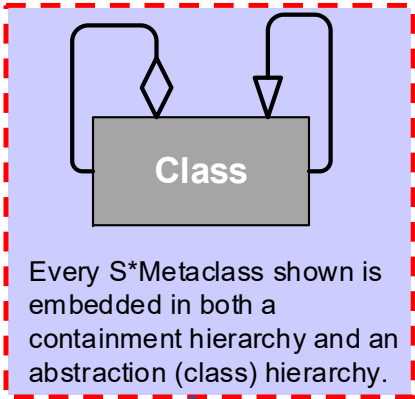

**Containment (Part-Whole) Hierarchy:**

- Vehicle System
- Vehicle Propulsion System
- Braking System
- Brake

Functional Roles (Logical Systems)

Important to traditional engineering decomposition and Bill-of-Materials

**Class (General-Special) Hierarchy:**

- Vehicle System
- Ambulance Vehicle System
- Military Ambulance Vehicle System
- Mil Ambulance Vehicle, configured for Desert.

Functional Roles (Logical Systems)

Important to pattern management, product line engineering, economics of re-use



# Stakeholder Features; clarifying SE views of value, selection, risk, FMEA, configuration

- Stakeholder Features model, in the language and conceptual values framework of the respective Stakeholders, chunks of value:
  - what is “at stake”
  - Often may be quite subjective
- Notice that we are describing twice the external behavior exhibited by the system of interest:
  - Interactions (and the Technical Requirements that will go with them) describe what is wanted in objective testable terms common to engineers.
  - Features describe the same system, but in terms of what is valued, Measures of Effectiveness (MOEs), etc.
- Analogous to pre-model engineering practice of “Customer Requirements” and “Technical Requirements” (other terms also used included “Product Requirements”, “System Requirements”, etc.)
- Two different ontologies, in a many-to-many mesh!

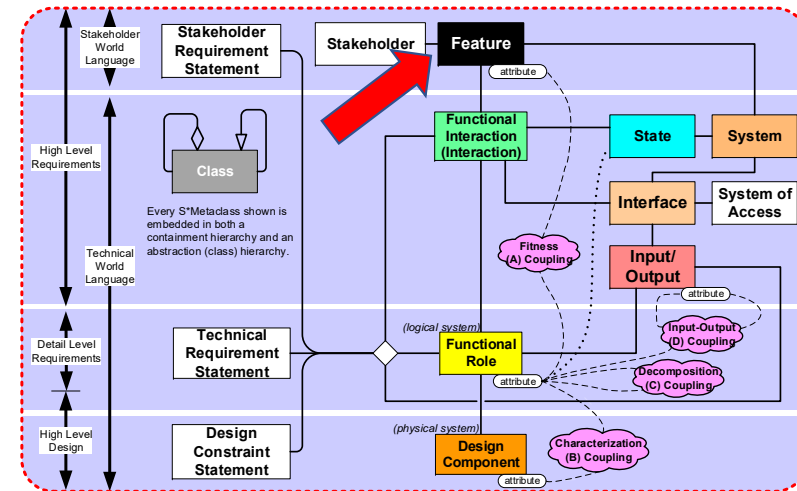

S\*Metamodel informal summary pedagogical diagram (formal S\*Metamodel includes additional details.)

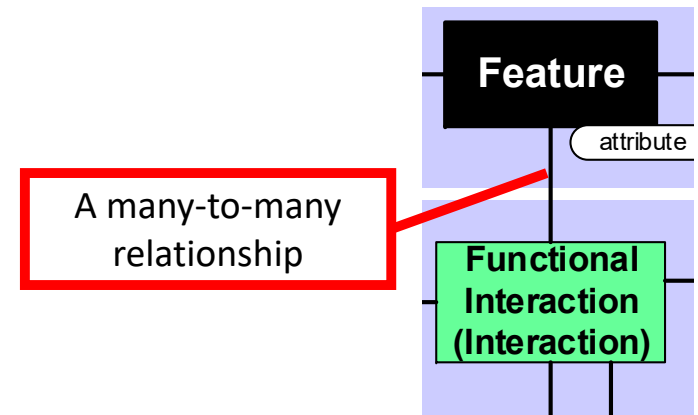

# Stakeholder Features: Vehicle example

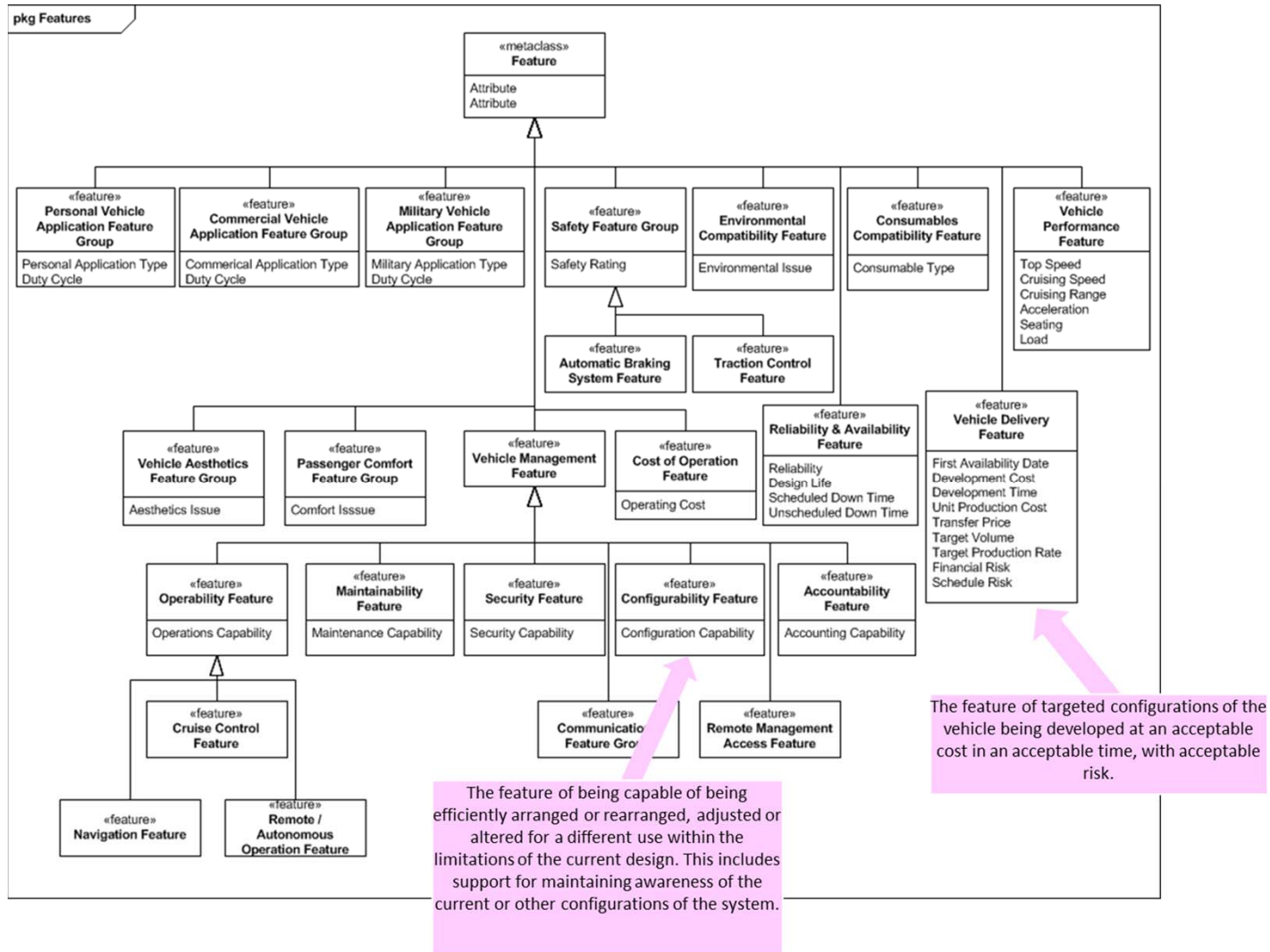

# Feature configuration space: Bigger than expected

Like the Tardis: Bigger  
on the Inside!



A perhaps surprising thing about Features is that they model a lot more than might be thought of at first when considering “value”:

- Features discover examples of models that are both “too small” and “too large” (redundant and conflicting) at the same time.

1. Features model the trade-space for optimization and trades—that one is not too surprising, but serves as a reminder to include the full range of stakeholder issues, not just end customer Features—who are all the stakeholders? The resulting Pareto Frontiers are in Feature Configuration Space.
2. All *purpose*, even when discovered by emergence and agile pivots, is in Feature Space.
3. All *risk is risk to Stakeholder Features*. So, the whole outcomes side of any Risk model should terminate in Feature space.
4. All *Effects (the “E” part in FMEA analyses) are effects in Feature Space*. Not realizing this, they are often described completely separately—a redundancy that costs a lot when not used to reinforce and improve both the positive and negative sides of models. (More on this when we cover model-based FMEAs.) This also applies to Consequences described in Safety and Cyber analyses.
5. All *product line segmentation / selection is described in Feature Space*. (More on this as you learn about S\*Patterns and pattern-based methods.)

# States, State Variables

- In general, a State is a condition of a system, described by its State Variable(s) (e.g., position, velocity acceleration, temperature, pressure, etc.):
  - The state of a system component may determine its input-output behavior (even if statistical) during Interactions in which it participates.
- For the important special case of model-based Finite State Machines (FSMs; finite automata), a State is a single value of the related state variable, represented by one block of an FSM diagram, . . .
  - representing a condition, mode, or situation, persisting for a period of time,
  - during which the system exhibits behavior described by associated Interaction.
  - We may model “State Transitions” from one finite State to another (typically instantaneous).
  - Those transitions may be caused by modeled State Transition Trigger Events.

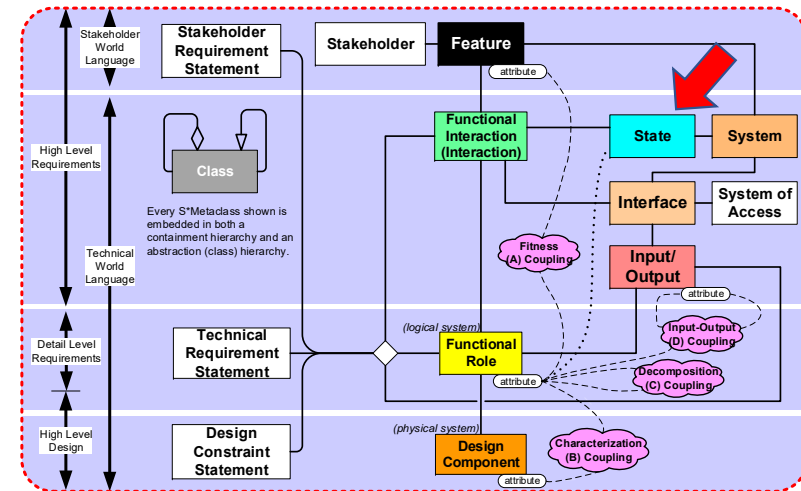

S\*Metamodel informal summary pedagogical diagram  
(formal S\*Metamodel includes additional details.)

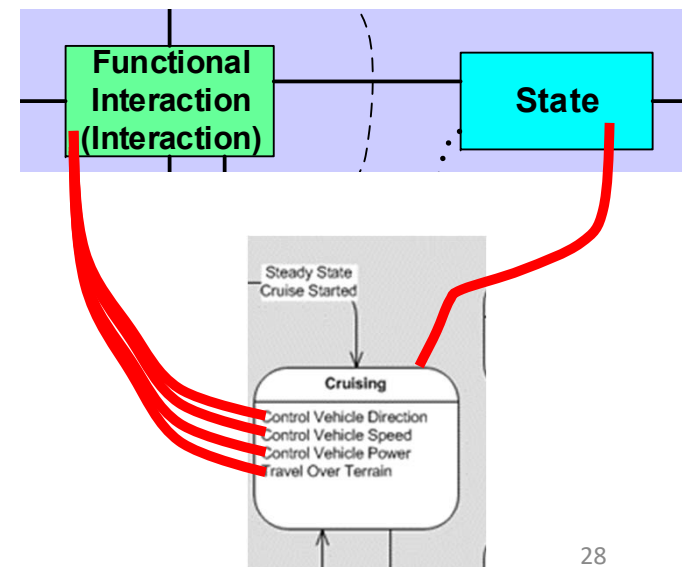

# States: Vehicle example

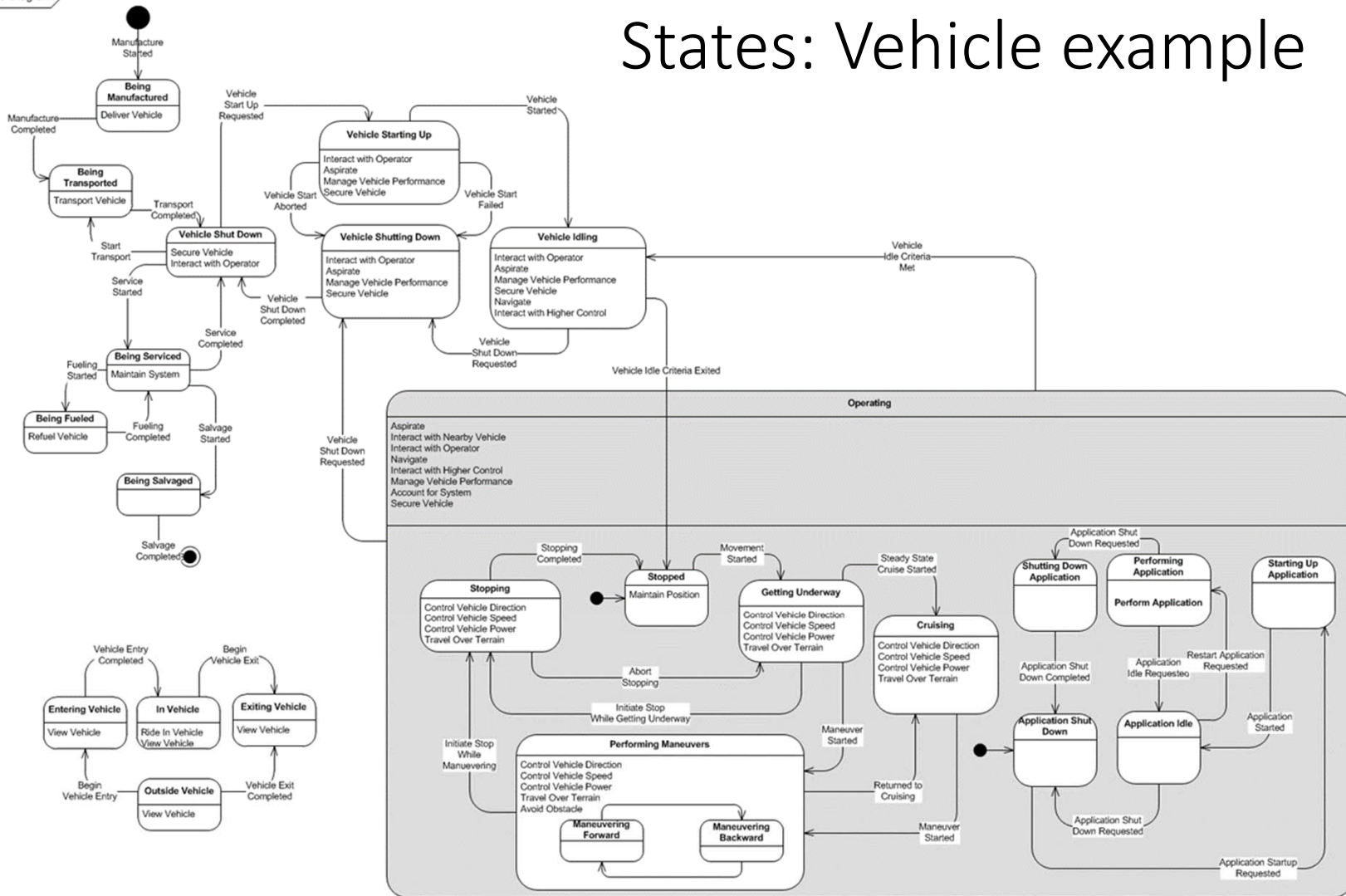

# Three paths to finding all the Interactions

- It turns out that “discovering all the Interactions” that need to be modeled is very important:
  - You will eventually learn how this can greatly help us “find all the Requirements” for a system.
- So, the following is provided as a powerful way to “find all the Interactions”:
- There are three orthogonal paths to Interactions in the S\*Metamodel:
  1. Feature-Interaction pairs tell us “why” an Interaction occurs.
  2. State-Interaction pairs tell us “when” an interaction occurs.
  3. Actor/Interface – Interaction pairs tell us “who or what” engages in interaction.

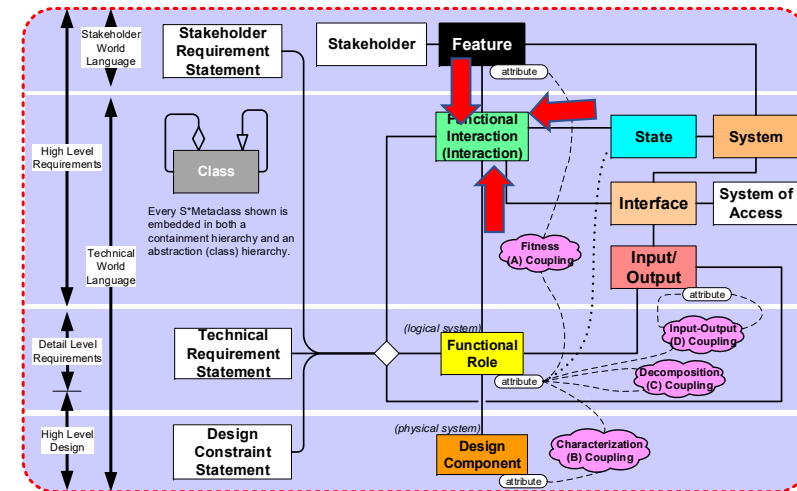

S\*Metamodel informal summary pedagogical diagram  
(formal S\*Metamodel includes additional details.)

- The same interactions should appear in all three lists!
- However, it is very common to discover, for one of these three different perspectives, missing interactions that need to be added to all three.

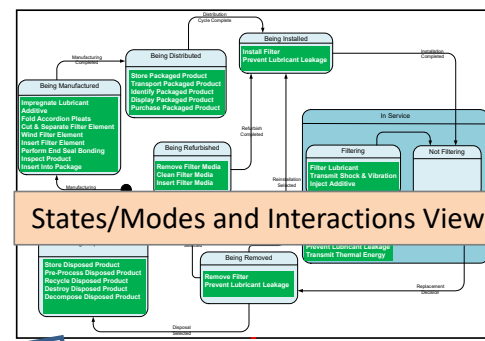
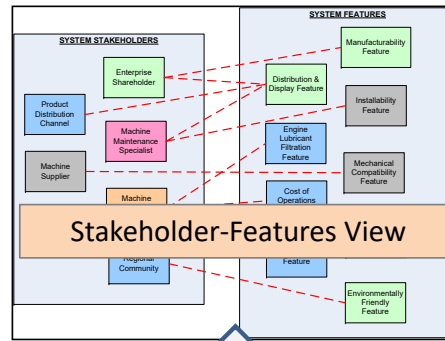
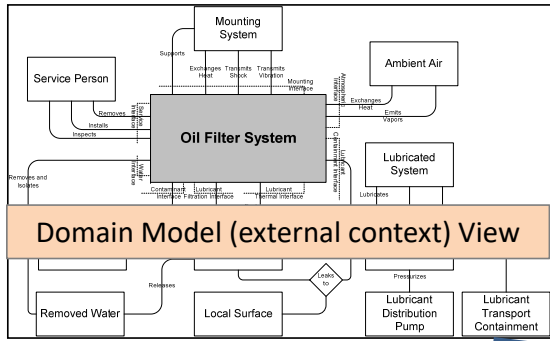

**Interactions-Actors Associations**

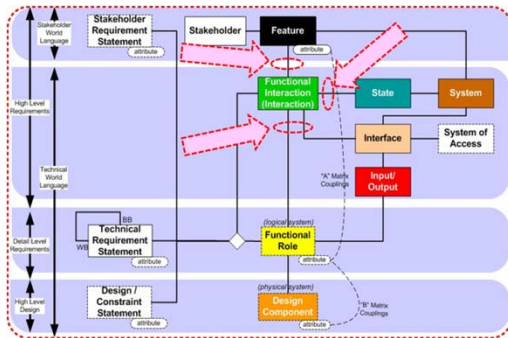
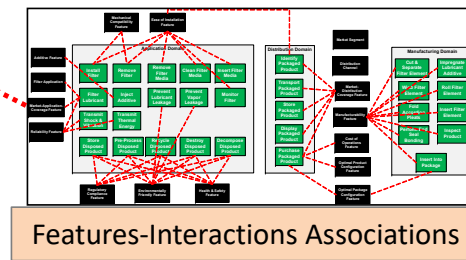
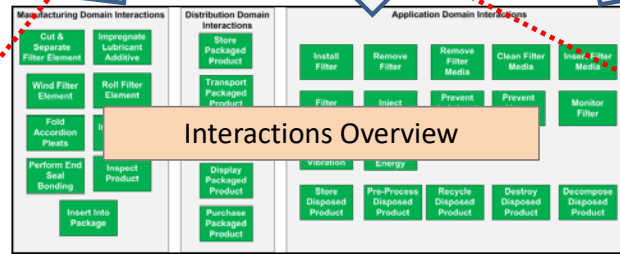

**Inherent Relational Checks of  
High Level Model  
 Completeness / Consistency  
 (Model Metrics)  
 Three paths to the same Interactions**

# Patterns push us toward better model completeness and consistency

- The above means that a system model is not likely to be complete if it does not include:
  - Some form of domain model, showing all external actors/external interfaces.
  - Some form of state model, showing all possible system black box states.
  - Some form of stakeholder feature model, showing the stakeholders' value space.
- A listing of all the external interactions of the system of interest:
  - Mapped to its external actors/external interfaces
  - Mapped to its feature model
  - Mapped to its state model
- . . . that “covers” all the actors, features, and states.



## Examples of Each **Attribute Coupling** Type:

- **Fitness Couplings:** How is technical behavior valued by stakeholders? e.g., Surgical Installation Time.
- **Decomposition Couplings:** (AKA Emergence Couplings) How does component or subsystem performance impact system performance? e.g., Timing Stability Coupling.
- **Characterization Couplings:** How does the identity of material, chemical composition, or part number predict behavior of same item? e.g., Connection Lead Life as a function of Lead Material.
- **Input-Output Couplings:** How does a role input impact a role output? e.g., Waveform Detection time, as a function of Input Waveform.

## Classes of parametric couplings

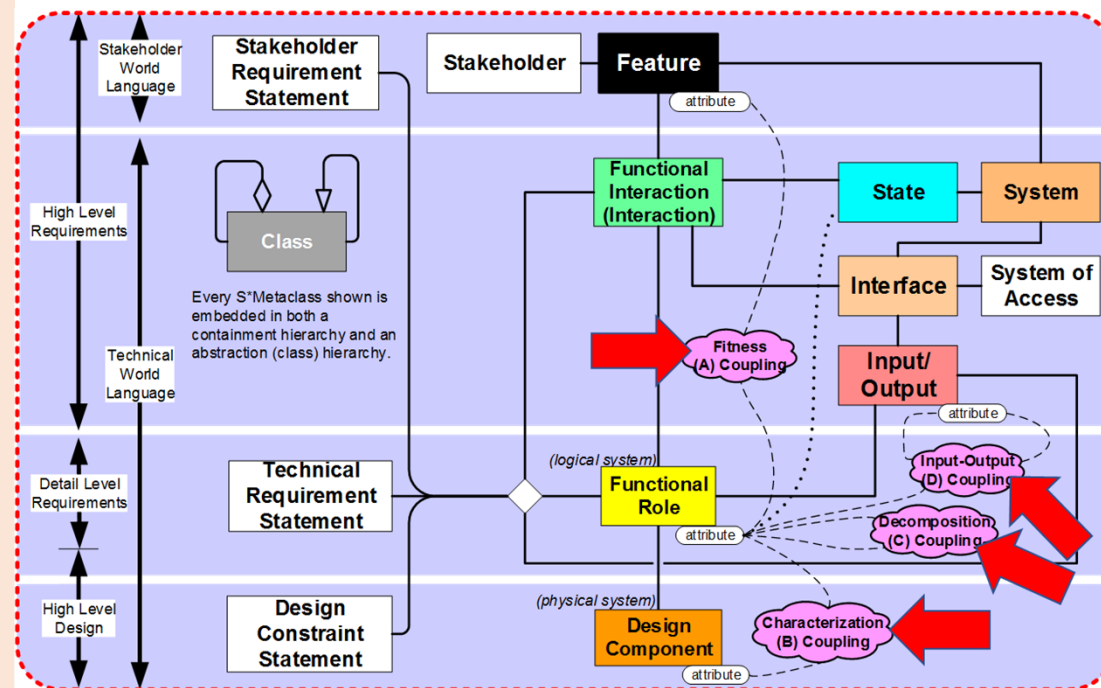

S\*Metamodel informal summary pedagogical diagram  
(formal S\*Metamodel includes additional details.)

# Integration of the Risk Model

- Traditional systems engineering example risk analysis representations are well-established, and can be found in:
  - Failure Modes and Effects Analysis (FMEA) or Failure Modes, Effects, and Criticality Analysis (FEMCA).
  - Special cases for risks of designs, risks of production and other processes, risks introduced by human operators (D-FMEA, P-FMEA, A-FMEA).
  - Fault Tree Analysis (FTA).
  - Preliminary Hazard Analysis (PHA).
  - Reliability Centered Maintenance (RCM) analysis.
  - Hazards and Operability Analysis (HAZOP).
  - Safety and Cybersecurity Analysis cases of the above.
- S\*Models and S\*Patterns teach us that Feature Space becomes the key representation of Risk, generating the above analyses from an integrated model.

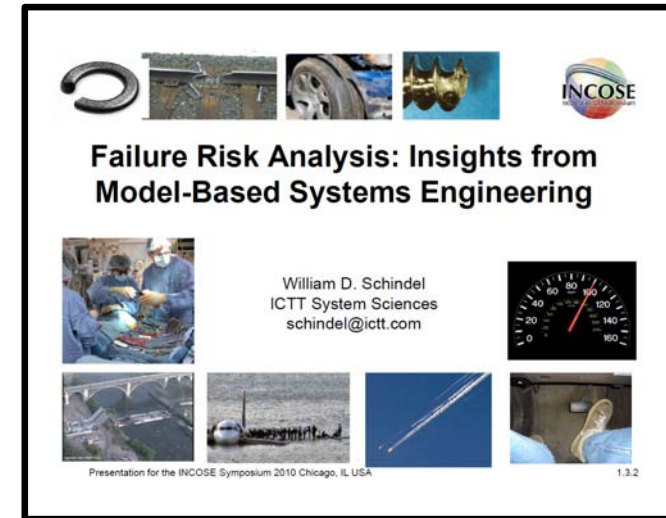

[https://www.omgwiki.org/MBSE/lib/exe/fetch.php?media=mbse:patterns:improving\\_failure\\_analysis\\_using\\_mbse\\_v1.3.2.pdf](https://www.omgwiki.org/MBSE/lib/exe/fetch.php?media=mbse:patterns:improving_failure_analysis_using_mbse_v1.3.2.pdf)



# S\*Patterns

- S\*Patterns are S\*Models of classes or families of systems.
- They are intended to be configurable, re-usable, and accumulate learning.
- They are often patterns of “whole systems”, as opposed to components.
- They are model-based patterns (there is a long history of other patterns).
- As S\*Models, they are based on the S\*Metamodel (in any tooling & language).

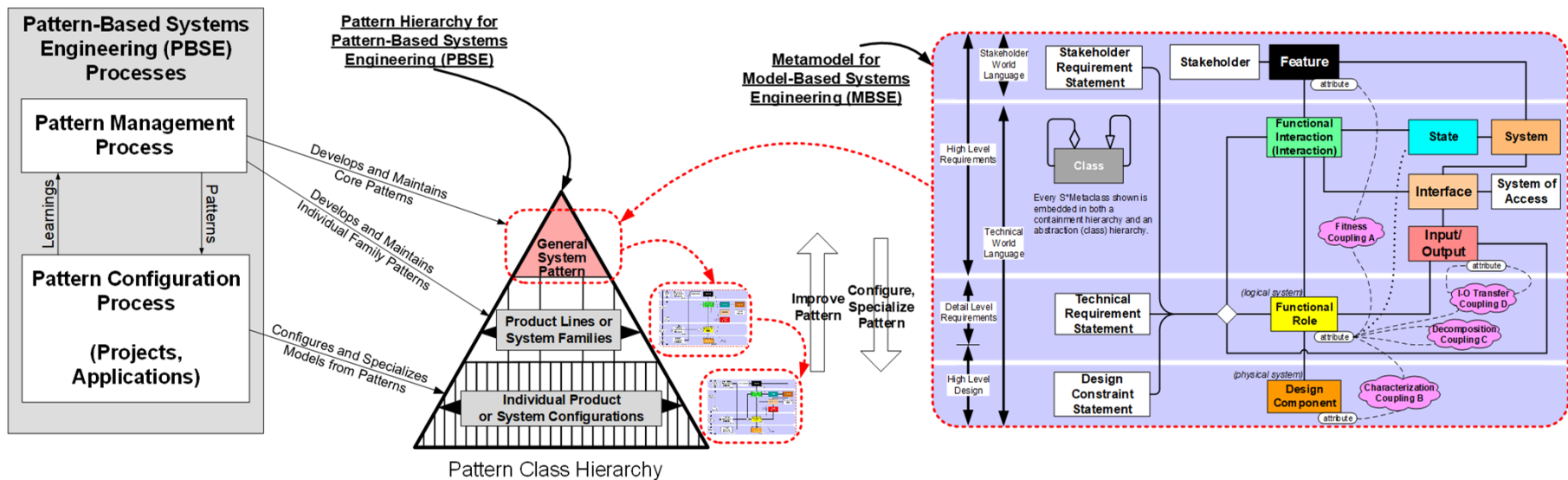

# S\*Pattern Configuration, Specialization

## Pattern-Based Systems Engineering (PBSE)

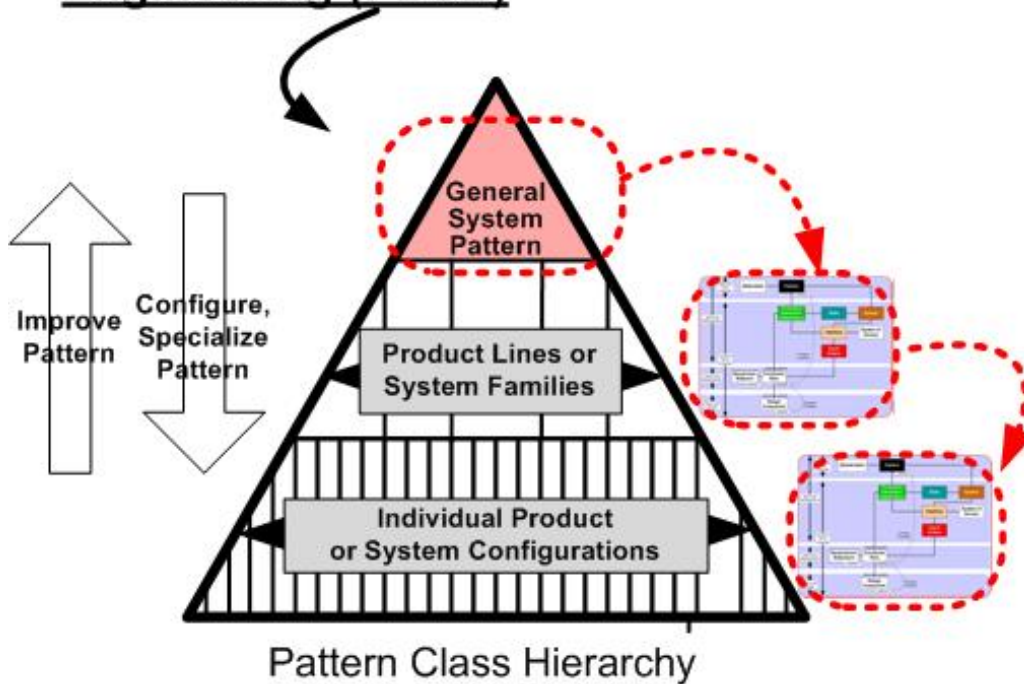

- Specialization transforms from an upper pattern to a more specialized (lower) pattern / model.
- Configuration is a special case of specialization, requiring less modeling skill:
  - Populate (*including multiply*) or depopulated classes and relationships.
  - Set Attribute Values.That's all!
- Configurable patterns are the “sweet spot” targeted by S\*Patterns.



More  
General

## Emergence of Patterns from Patterns: S\*Pattern Class Hierarchy

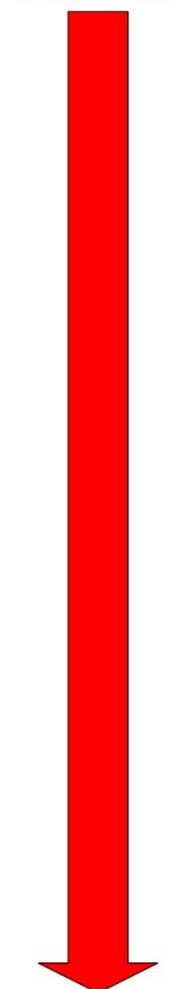

More  
Specific

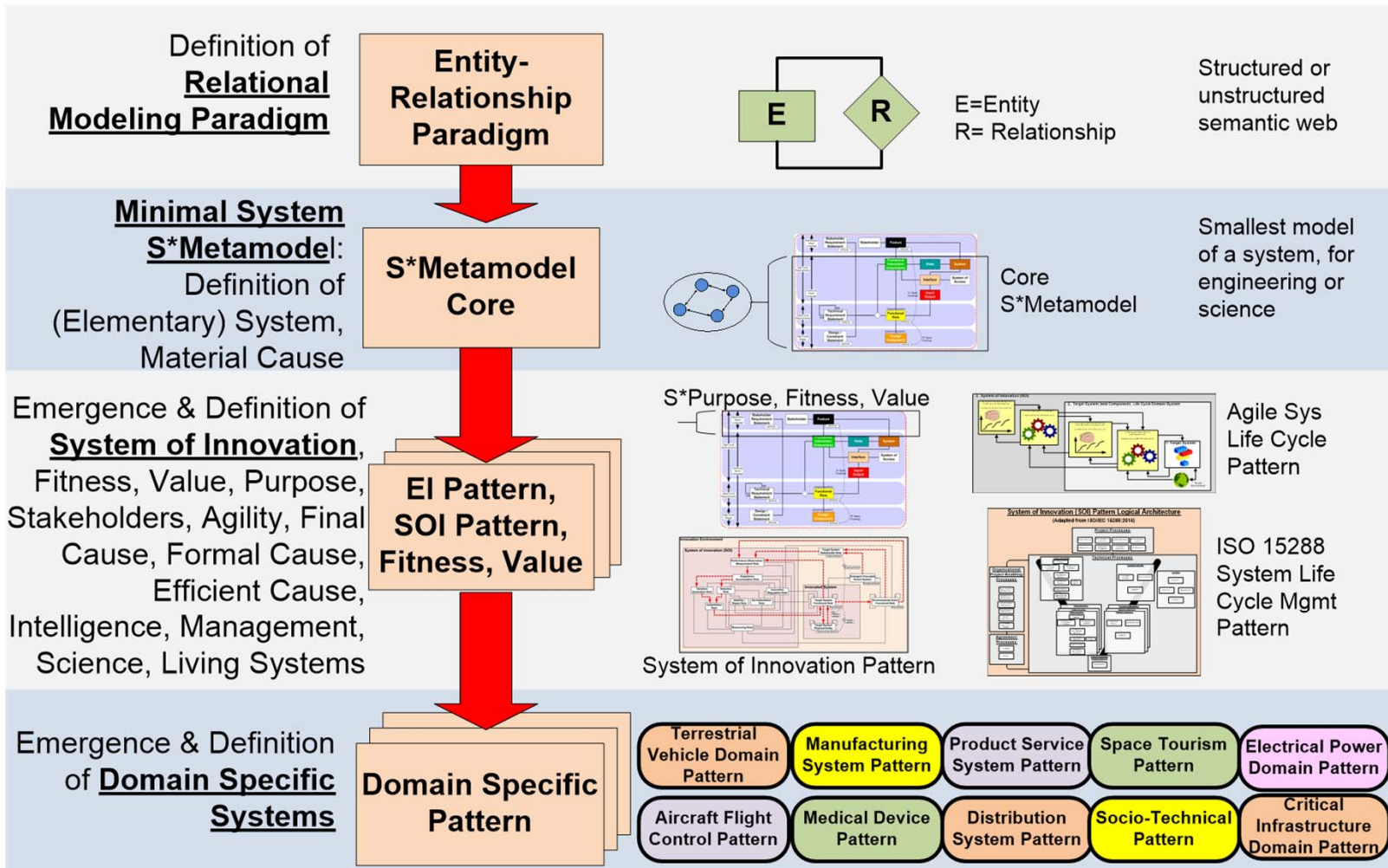

# Models from Patterns: Overview of MBSE Pattern Configuration Algorithm

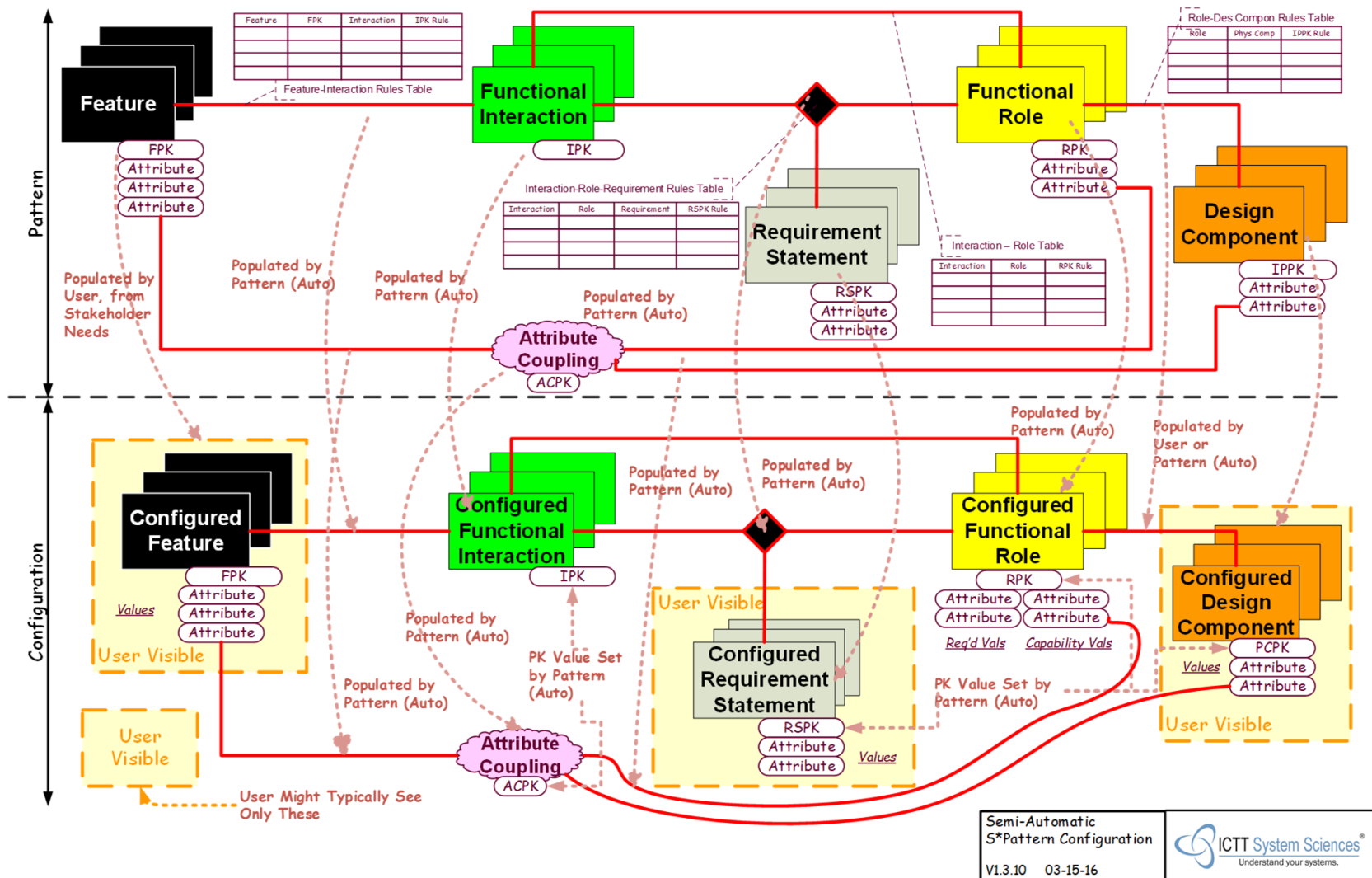

# Propagation of configuration population is inherent to the nature of all engineered systems

- S\*Feature Space drives configuration from a smaller set of (stakeholder based) degrees of freedom / points of variation.
- Simplifies Product Line Engineering (PLE) model configuration rule-making and integrates PLE.

Inherent PLE degrees of freedom configuration propagation:

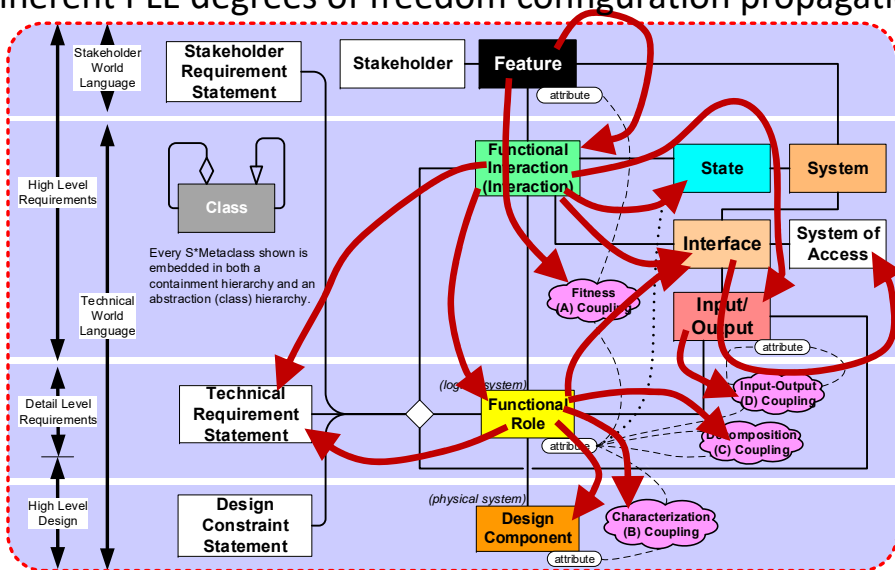

	POPULATED METACLASSES ("THEN")																							
	Feature	Interaction	Role	Design Component	Requirement Statement	State	Event	Transition	Interface	Architectural Relationship	Input/Output	Port	System of Access	Failure Impact	Counter Requirement Statement	Failure Mode	Feature Attribute	Role Attribute	Design Component Attribute	Input/Output Attribute	Fitness Attribute Coupling	Decomposition Attribute Coupling	Characterization Attribute Coupling	IO Attribute Coupling
TRIGGERING METACLASSES ("IF")																								
Stakeholder Input																								
Feature	■																							
Interaction		■																						
Role			■																					
Design Component				■																				
Requirement Statement					■																			
State						■																		
Event							■																	
Transition								■																
Interface									■															
Architectural Relationship										■														
Input/Output											■													
Port												■												
System of Access													■											
Failure Impact														■										
Counter Requirement Statement															■									
Failure Mode																■								
Feature Attribute																	■							
Role Attribute																		■						
Design Component Attribute																			■					
Input/Output Attribute																				■				
Fitness Attribute Coupling																					■			
Decomposition Attribute Coupling																						■		
Characterization Attribute Coupling																							■	
IO Attribute Coupling																								■

# Relationship to Feature-Based PLE ala' ISO 26580

Very similar in the PLE aspects, with a few differences:

- ISO26580 PLE specifies modeling what changes, but specifies omitting what does not change; S\*Feature models include baseline capabilities.
- ISO26580 refers to all the points of variation as “Features”, with rules to be established between them; S\*Patterns begins with a smaller set of “Stakeholder Features” degrees of freedom in stakeholder value space, then recognizes all the other points of variation throughout the model but connects them with each other up to the Stakeholder Features points of variation.
- This shows that the number of real degrees of freedom, after considering constraints, is smaller.
- Effectively complies with ISO26580 while making its use simpler and more integrated.



# Automation aids for pattern configuration

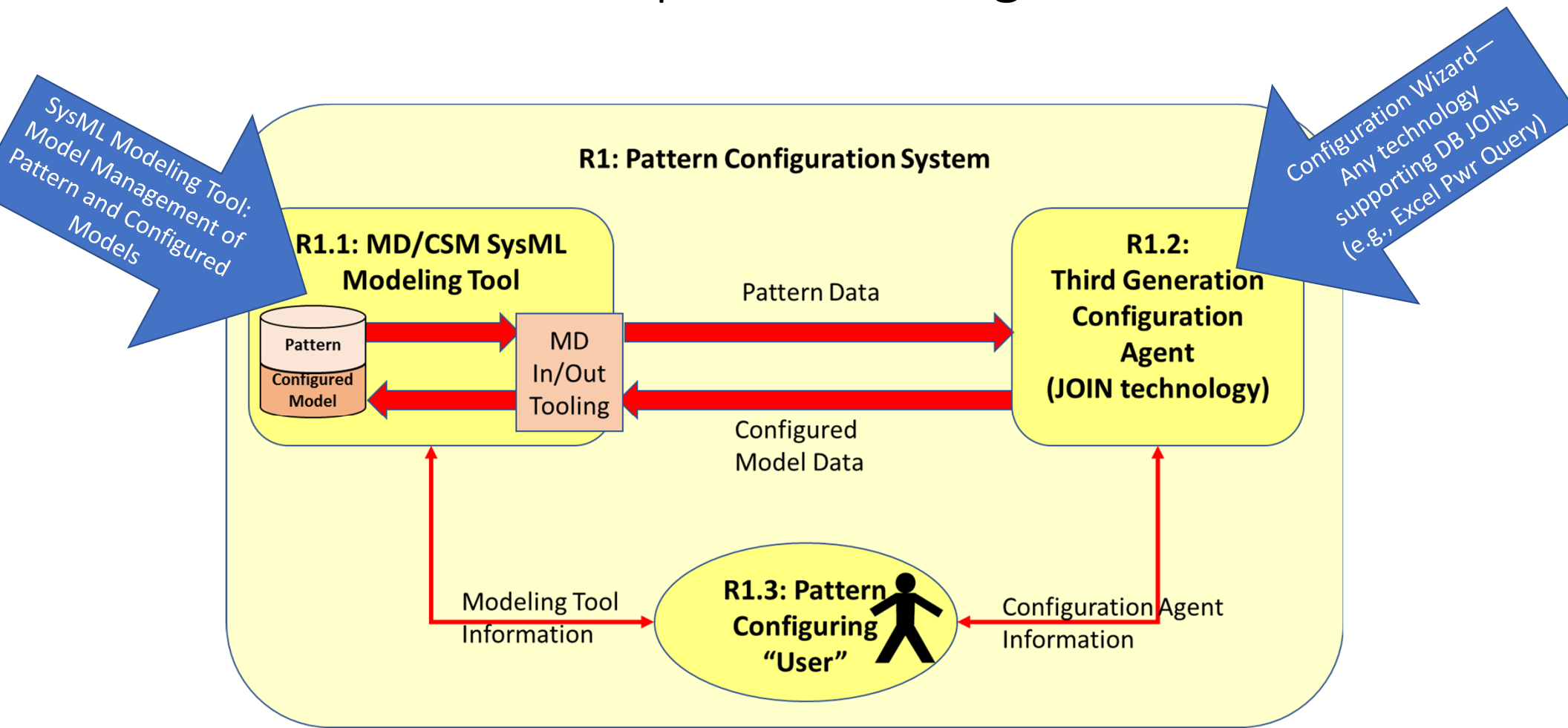

# Config. Wizard User's Feature Selection Interface (Including Feature Primary Key Value Population)

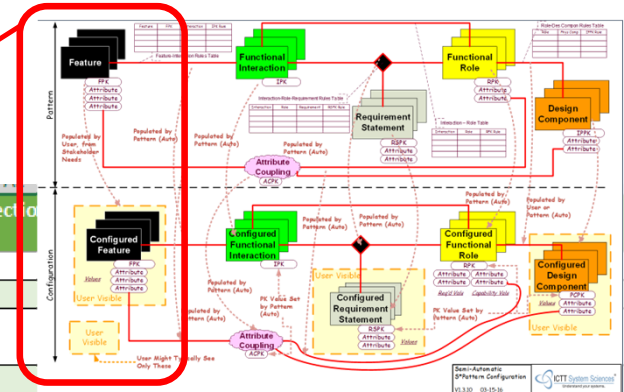

	Feature	Feature Name	Feature Attribute	Populate? Yes/No	Selection 1	Selection 2	Selection 3	Selection 4	Selection 5	Selection 6
1	Configurative									
9	Mandatory	Cruise Control Feature								
10	Optional	Environmental Compatibility	Environmental Issue							
	Mandatory	Maintainability Feature	Maintenance Capability							
11	Optional	Military Vehicle Application Feature Group	Military Application Type							
12	Optional	Navigation Feature	Navigation Capability							
13	Mandatory	Operability Feature	Operations Capability	Yes	Automatic Performance Data Measurement and Display	Automatic Performance Threshold Detection and Reporting	Maneuverability			
14	Optional	Passenger Comfort Feature Group	Comfort Issue				Automatic Performance			
15	Optional	Personal Vehicle Application Feature Group	Personal Application Type				Automatic Performance			
16	Mandatory	Reliability & Availability Feature					Maneuverability			
17	Optional	Remote Management Access	Remote Access Capability				Manual Performance			
18	Optional	Remote-Autonomous Operation		No			Operations Procedure			
19	Mandatory	Safety Feature Group					Visibility			
20	Optional	Security Feature	Security Management Capability	No	Automatic Operational Privileges Authorization	Identification and Authentication	Physical Access Locks	Security Data Management		
21	Optional	Traction Control Feature		No						
22	Optional	Vehicle Aesthetics Feature Group	Aesthetics Issue	No	Exterior Body Style	Exterior Color Galeon Blue	Exterior Color Handon Green	Interior Color Rich Brown	Interior Color Sand Dune	Overall Passenger
23	Mandatory	Vehicle Delivery Feature		No						
24		Vehicle Management Feature		No						
25	Mandatory	Vehicle Performance Feature		No						

Selection of Feature Primary Key Values

# How to find out more about configurable model-based patterns

[https://www.omgwiki.org/MBSE/lib/exe/fetch.php?media=mbse:patterns:pbse\\_tutorial\\_glrc\\_2016\\_v1.7.4.pdf](https://www.omgwiki.org/MBSE/lib/exe/fetch.php?media=mbse:patterns:pbse_tutorial_glrc_2016_v1.7.4.pdf)

[https://www.omgwiki.org/MBSE/lib/exe/fetch.php?media=mbse:patterns:pbse\\_extension\\_of\\_mbse--methodology\\_summary\\_v1.6.1.pdf](https://www.omgwiki.org/MBSE/lib/exe/fetch.php?media=mbse:patterns:pbse_extension_of_mbse--methodology_summary_v1.6.1.pdf)

[https://www.omgwiki.org/MBSE/lib/exe/fetch.php?media=mbse:patterns:glrc\\_2018\\_tutorial--mbse\\_emerging\\_issues\\_v1.4.2.pdf](https://www.omgwiki.org/MBSE/lib/exe/fetch.php?media=mbse:patterns:glrc_2018_tutorial--mbse_emerging_issues_v1.4.2.pdf)



Bill Schindel  
schindel@icct.com



Troy Peterson  
tpeterson@systemxi.com

## Introduction to Pattern-Based Systems Engineering (PBSE): Leveraging MBSE Techniques



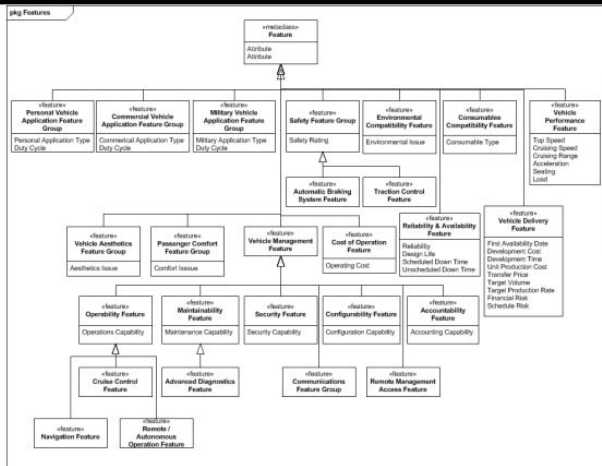



INCOSE Great Lakes Regional Conference 2016  
Copyright © 2016 by Bill Schindel and Troy Peterson  
Published and used by INCOSE with permission

1.7.4



# Current working group projects, activities—status, Q&A

## Patterns & Technologies:

1. Semantic Technologies for Systems Engineering (ST4SE) Project.
2. Adaptive Learning Ecosystem Pattern—the INCOSE ASELCM Reference Framework.
3. Universal Model Metadata Wrapper: Model Characterization Pattern (MCP), w/ASME VV Stds Cmte & V4 Inst.
4. S\*Pattern Configuration Wizard.

## Publications:

1. Minimal S\*Models—A Primer (including S\*Metamodel and its formal mappings to OMG SysML and tools)
2. S\*Patterns Primer (second ed)
3. ASME Guideline for Managing Credibility of Models for Adv. Manufacturing, w/ASME VV50 Stds Working Grp.
4. AIAA Aerospace Digital Twins Case Studies Pub; Digital Twin Analysis and Planning Reference Pattern, w/AIAA.
5. AIAA Aerospace Digital Threads Position Pub; Digital Thread Analysis & Planning Reference Pattern, w/AIAA.
6. *Handbook of System Sciences*, for ISSS via Springer: Chapter: “Patterns in Science and Engineering”, w/ISSS.
7. *Handbook of Model-Based Systems Engineering*, Madni & Augustine, eds, Springer, Chapter: “MBSE Patterns”.
8. *INCOSE SE Handbook*, 5<sup>th</sup> Ed., for INCOSE, D. Walden et al, eds, material on S\*Metamodel and ASELCM Pattern
9. Support for Vision 2035 Implementation Streams: Innovation Applications, SE Foundations.
10. *INCOSE INSIGHT*, Dig. Engg. Issue, 2022, F. Salvatore, ed, Realizing the Promise of Digital Engineering: The Innovation Ecosystem Reference Pattern for Analysis, Planning, and Implementation.

# Interface Pattern Project (became part of ST4SE Project)



- Configurable patterns for Interfaces of all types
- Originally suggested by Frank Salvatore
- Initial work during 2017-2019
- Became part of ST4SE Project in 2020
- Additional progress on configurable Interface Pattern achieved in 2021-2022 as part of Semantic Technologies for Systems Engineering (ST4SE) Project.



# Interface Pattern Project

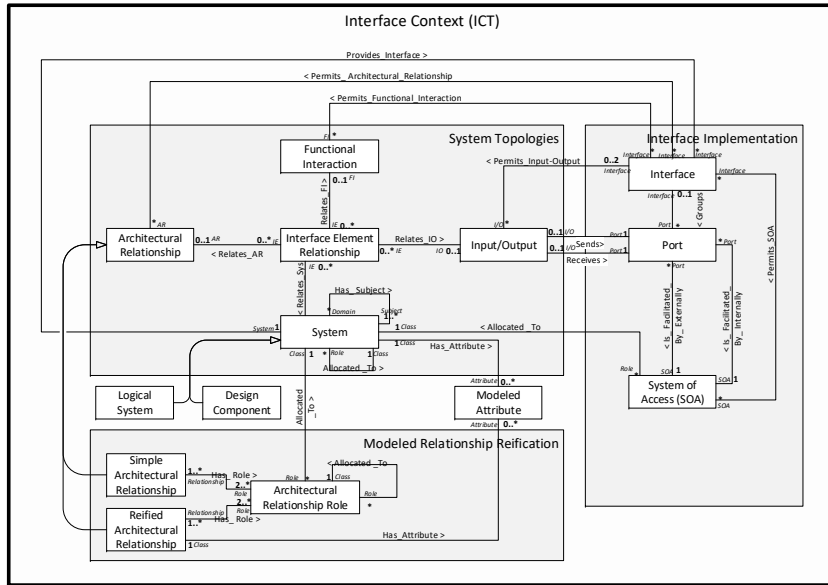

Generic S\*Metamodel—  
Includes Interface Pattern

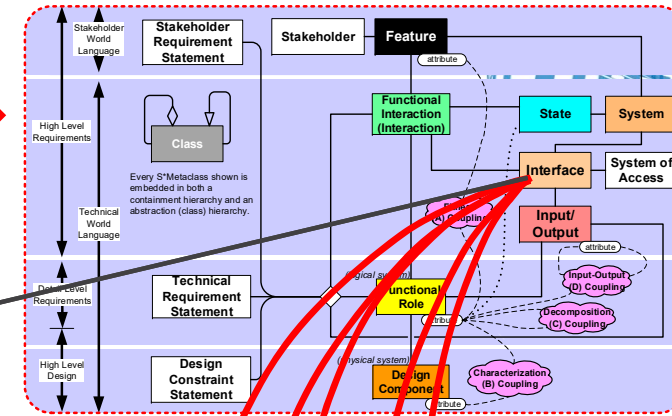

Improved Generic Interface Pattern  
(2021), a Subset of S\*Metamodel

Configurable International Power Converter MBSE S\*Pattern—Includes Family of Configurable Electrical, Mechanical, and Information Interfaces in ST4SE Project (2020-2022)

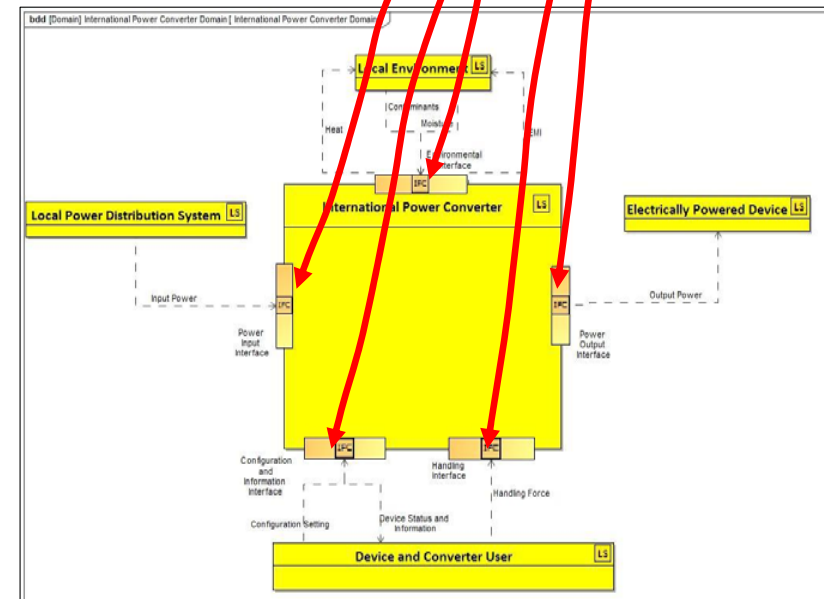

# Semantic Technologies for Systems Engineering (ST4SE)

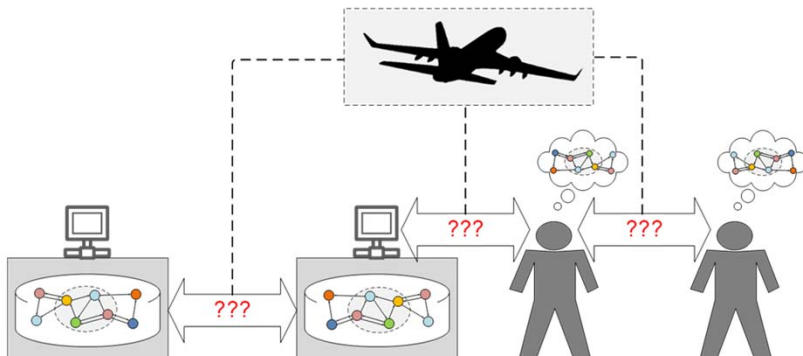

*Suggested by S. Jenkins, H-P deKoning. INCOSE TPP:  
[http://www.omgwiki.org/MBSE/lib/exe/fetch.php?media=mbse:patterns:incose\\_patterns\\_wg\\_st4se\\_project\\_tpp\\_v2.0\\_signed.pdf](http://www.omgwiki.org/MBSE/lib/exe/fetch.php?media=mbse:patterns:incose_patterns_wg_st4se_project_tpp_v2.0_signed.pdf)*

- This project combines demonstration of (1) automated generation of consistent trustable models from trusted model-based patterns with (2) automated checking of human-generated models against trusted model-based patterns.
- Human beings may be the original interpreters of the meaning of models, but non-human semantic technologies have joined human interpreters of meaning.
- Information technologies that deal with model semantics (encoded meaning) include modeling languages, model authoring tools, simulation engines, web-based semantic data structures, and query and reasoning technologies.
- Semantic technologies strengthen impact of model-based semantics on engineering.
- Technical Product Plan: INCOSE distribution of data structures, not just documents.
- Interested participants can be part of evaluating utility and new distribution paradigms.

# Semantic Technologies for Systems Engineering (ST4SE)

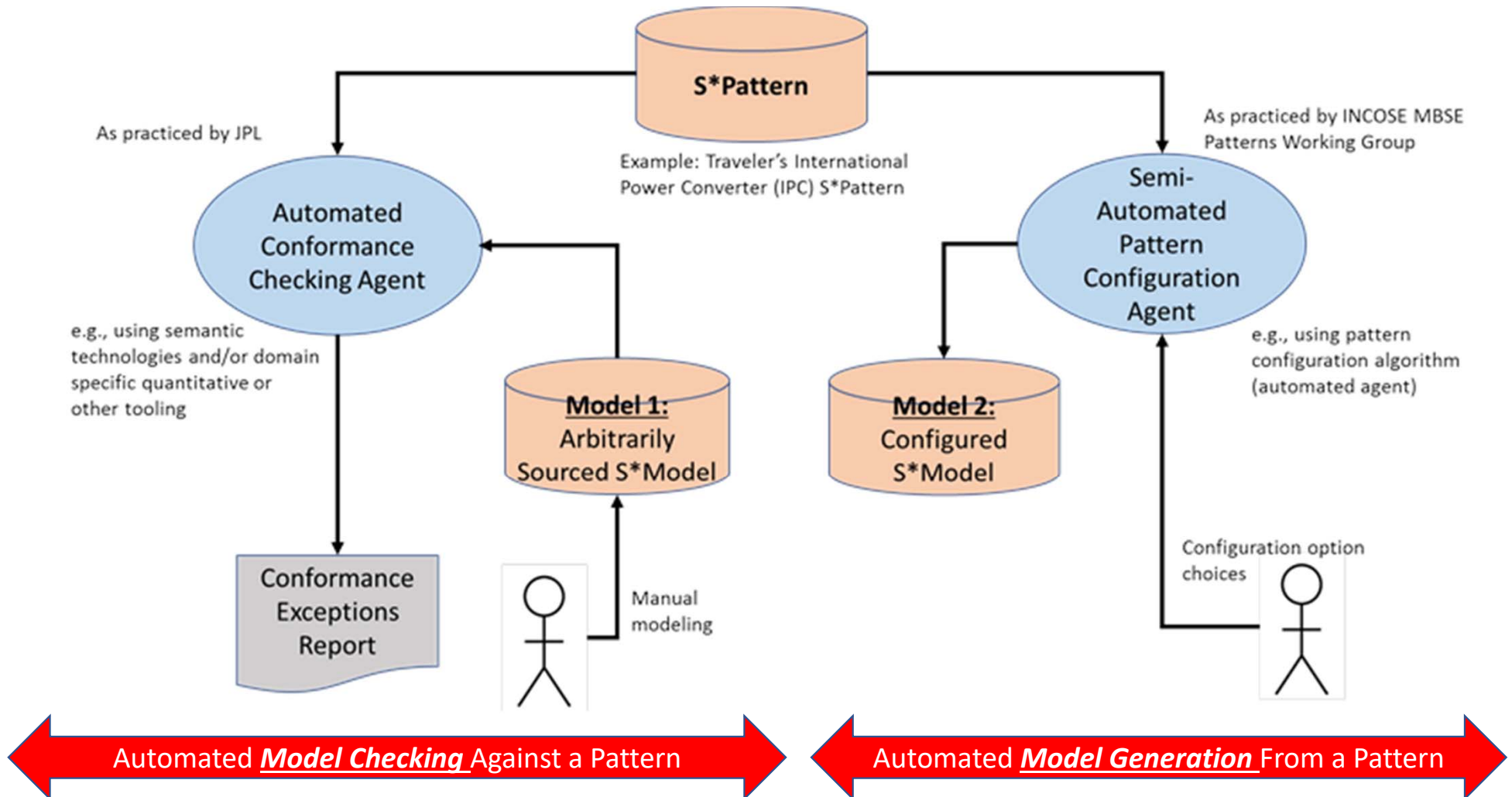



# ST4SE Project Report: Completed in late 2022

INCOSE MBSE Patterns Working Group Report:  
Semantic Technologies for Systems Engineering (ST4SE) Project

Version 1.10.6  
Oct 31, 2022



INCOSE Patterns WG Report--ST4SE Project--1.10.6.docx  
Copyright 2022 by INCOSE Patterns Working Group

## INCOSE MBSE Patterns Working Group Report--ST4SE Project

### Contents

Project Team and Acknowledgements	3
<b><u>In a Nutshell: ST4SE--What Problem Are We Solving, and How? What Value to Me?</u></b>	4
1 Report Purpose, Scope, Intended Readership	5
2 Background and Pre-Requisite Knowledge	5
2.1 INCOSE MBSE Patterns Working Group and the Value of Model-Based Patterns	5
2.2 Basics of Semantic Technologies, Ecosystem Models, S*Models, and S*Patterns	6
2.3 Beyond the Basics: How to Learn More	13
3 Summary of the Project	16
3.1 Consistency Management as a Paradigm for Engineering and Life Cycle Management	16
3.2 The Interface Pattern; Use in the Traveler Power Converter Pattern	18
3.3 Enhanced Generation of a Model Consistent with a Trusted Pattern	18
3.4 Teams, Scale, and Trust: Implications in the Larger Innovation Ecosystem Environment	26
4 Tooling and Technologies Utilized	27
4.1 Semantic Technologies Applied, Placed in the Larger Information Ecosystem	27
4.2 Modeling Languages and Representations Utilized	28
4.3 Modeling, Semantic, and Pattern Configuring Tools Utilized	30
5 Project Results Demonstrated	34
5.1 Enhanced Generation of a Model from a Trusted Pattern	34
5.2 Enhanced Checking of a Model Against the Same Trusted Pattern	37
5.3 Gaining Access to the Project's Tooling and Information	41
6 Observations, Conclusions, and Implications for Action	42
6.1 Observations During the Project	42
6.2 Project Conclusions	45
6.3 Explore and Gain from this Project: Suggested Incremental Actions You Can Take	45
6.4 Additional Questions for Future Work	45
7 Engaging with the S*Patterns Community	46
8 Definitions	46
9 References	48
10 Document Change History	49

INCOSE Patterns WG Report--ST4SE Project--1.10.6.docx 2

## Semantic Technologies for Systems Engineering (ST4SE): A Project of the INCOSE MBSE Patterns Working Group

### Project Execution, Report Authoring, and Advisory Team:

Mark Blackburn, Stevens Institute of Technology  
Ken Cureton, U. of Southern California  
Hans Peter de Koning, European Space Agency (ESA)  
Steve Jenkins, NASA JPL  
Stephen Lewis, ICTT System Sciences  
Bill Schindel, ICTT System Sciences

### Acknowledgements

### Report Review Special Thanks To:

Joe Marvin, Prime Solutions Group  
Kathryn Trase, Ball Aerospace  
Dariusz Walter, BAE Systems Australia

### Previous Phase Interface Pattern Project Team:

Frank Salvatore, SAIC  
Jason Sherey, ICTT System Sciences  
Jonathan Torok, US Navy

(Affiliations listed above were at the time of activities referenced.)

INCOSE Patterns WG Report--ST4SE P



[https://www.omgwiki.org/MBSE/lib/exe/fetch.php?media=mbse:patterns:incose\\_patterns\\_wg\\_report--st4se\\_project--1.10.6.pdf](https://www.omgwiki.org/MBSE/lib/exe/fetch.php?media=mbse:patterns:incose_patterns_wg_report--st4se_project--1.10.6.pdf)

# Adaptive Learning Ecosystem Pattern—the Learning Ecosystem (ASELCM) Reference Framework

- Collaborating with INCOSE Agile SE WG, a reference pattern was contributed by Patterns WG during the two-year INCOSE study of agile SE practices of four major organizations during 2015-2017, leading to four published case studies. (Led by Rick Dove, Agile SE WG.)
- The original pattern (Agile SE Life Cycle Management (ASELCM) Operational Reference Pattern) was subsequently formalized by the Patterns WG as a configurable S\*Pattern in SysML, for the planning, analysis, and management of advancement in learning ecosystems for projects, enterprises, and supply chains.
- The resulting multi-layer pattern focuses on leveraging Digital Engineering to advance performance through the paradigm of strengthened Consistency Management.
- Those interested in participating can be a part of extension and application of this pattern in case studies of their own projects, enterprises, or supply chains, plus related tooling.

26<sup>th</sup> annual INCOSE International Symposium  
Edinburgh, UK  
July 18 - 21, 2016

## Introduction to the Agile Systems Engineering Life Cycle MBSE Pattern

Bill Schindel [schindel@ictt.com](mailto:schindel@ictt.com)  
Rick Dove [rick.dove@parshift.com](mailto:rick.dove@parshift.com)

1.8.8  
Copyright © 2016 by W. D. Schindel and R. Dove. Permission granted to INCOSE to publish and use.

[http://www.omgwiki.org/MBSE/lib/exe/fetch.php?media=mbse:patterns:is2016\\_intro\\_to\\_the\\_ase lcm\\_pattern\\_v1.4.8.pdf](http://www.omgwiki.org/MBSE/lib/exe/fetch.php?media=mbse:patterns:is2016_intro_to_the_ase lcm_pattern_v1.4.8.pdf)

## INCOSE Agile Systems Engineering Life Cycle Management (ASELCM) Pattern

### Consistency Management as an Integrating Paradigm for Digital Life Cycle Management with Learning

Including Computational Model VVUQ and Applications for Semantic Technologies

INCOSE/OMG MBSE Patterns Working Group  
09.27.2020 V1.2.3

Bill Schindel  
[schindel@ictt.com](mailto:schindel@ictt.com)

[https://www.omgwiki.org/MBSE/lib/exe/fetch.php?media=mbse:patterns:ase lcm\\_pattern -- consistency\\_management\\_as\\_a\\_digital\\_life\\_cycle\\_management\\_paradigm\\_v1.3.1.pdf](https://www.omgwiki.org/MBSE/lib/exe/fetch.php?media=mbse:patterns:ase lcm_pattern -- consistency_management_as_a_digital_life_cycle_management_paradigm_v1.3.1.pdf)

# Adaptive Learning Ecosystem Pattern—the Learning Ecosystem (ASELCM) Reference Framework

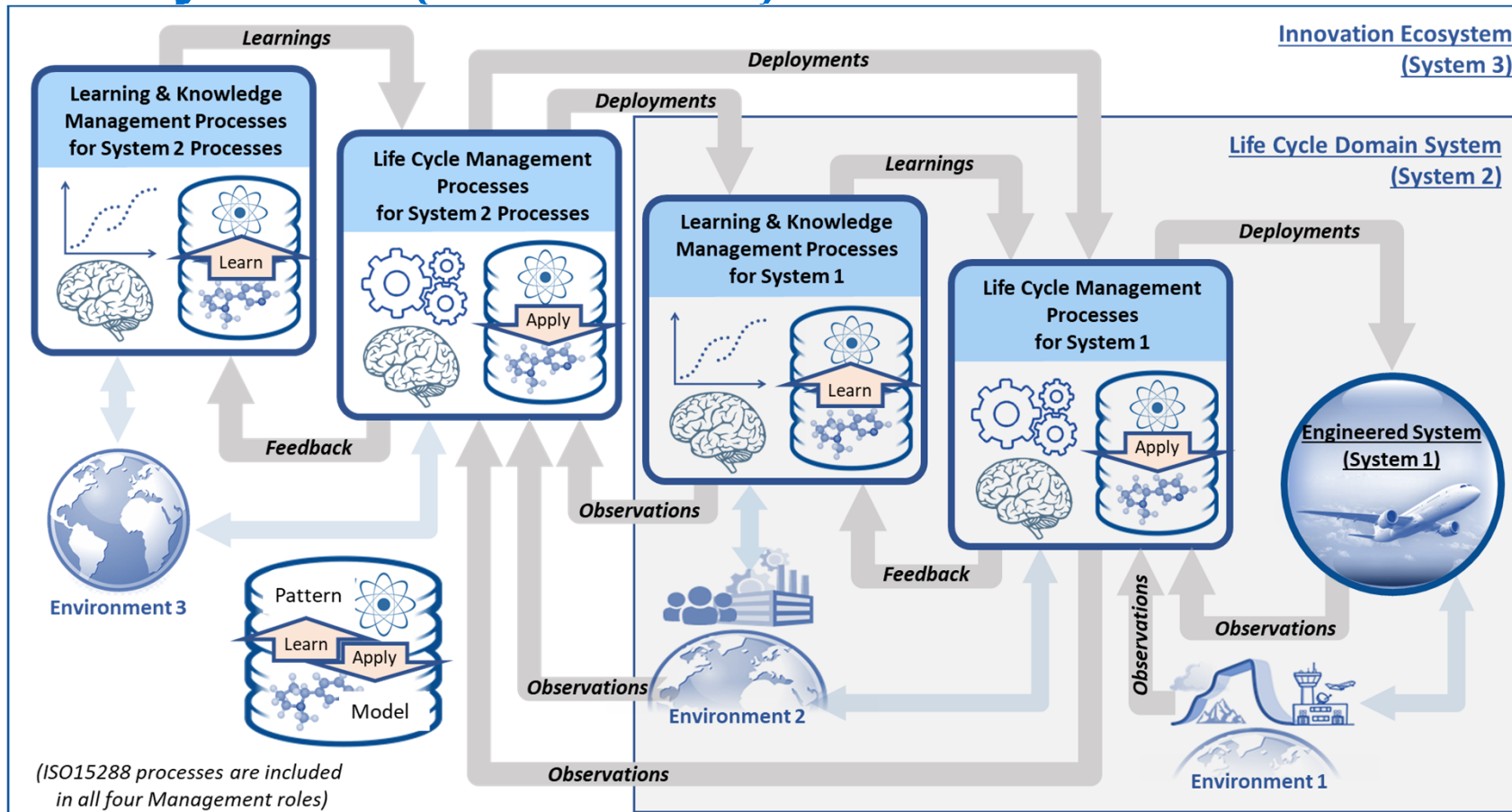

Pattern Description

AIAA Pattern Application



Being used at IW2023 for FuSE Vision 2035 Implementation: Innovation Application Workstream

# Adaptive Learning Ecosystem Pattern—the Learning Ecosystem (ASELCM) Reference Framework

*Annals of Biomedical Engineering*, Vol. 51, No. 1, January 2023 (© 2022) pp. 225–240  
<https://doi.org/10.1007/s10439-022-03083-z>

**BMES** BIOMEDICAL  
ENGINEERING  
SOCIETY



*S.I. : Modeling for Advancing Regulatory Science*

## Patterns in the Public Square: Reference Models for Regulatory Science

WILLIAM D. SCHINDEL

ICTT System Sciences, Terre Haute, IN, USA

(Received 7 May 2022; accepted 9 September 2022; published online 7 October 2022)

Associate Editor Joel Stitzel oversaw the review of this article.

**Abstract**—Science and engineering involve discovery, representation, explanation, and exploitation of recurrent patterns, observed as phenomena. Model-based representations describe not only natural phenomena and engineered products, but also the socio-technical systems of systems that carry out scientific study, product engineering, medical practice, public health, commerce, and regulation. The term “Regulatory Science” invites us to represent and understand innovation, regulation and their intended and actual consequences as observable system phenomena in their own right, using scientific and engineering principles, tools, and insights. This article summarizes three classes of model-based reference patterns central to representing, understanding, communicating, and enhancing systems of innovation, regulation, and improvement over life cycles. In order of increasing scale, these pattern classes are (1) the domain-independent pattern of model-based representation of system phenomena (the S\*Metamodel) in the sciences and engineering disciplines, underlying all modeling and simulation; (2) domain-specific patterns representing families of natural systems and engineered products in their life cycle contexts; and (3) the large-scale Innovation Ecosystem Pattern, in which science, engineering, commerce, medicine, and regulation are performed, planned, and advanced—including sharing of managed models and data across ecosystems. All

innovation ecosystems, including their regulatory and other aspects. The premise that this is even practically feasible rests upon an updated and more unified understanding of what is meant by “system level model”, based on the centuries longer traditions of models successfully used by physical sciences and mathematics. It is directly connected to this Special Issue’s theme of “Modeling for Advancing Regulatory Science”, and we assert that it provides key support for the US FDA’s related definition:

“Regulatory Science is the science of developing new tools, standards, and approaches to assess the safety, efficacy, quality, and performance of some FDA-regulated products.” (FDA)<sup>11</sup> (emphasis added)

Many large-scale human endeavors have grown up and proliferated through the evolutionary forces of large-scale interactions and selection processes. However, as whole interacting systems of systems, they have



# Universal Model Metadata Wrapper: The Model Characterization Pattern (MCP), w/ASME VV Standards Committee & V4 Institute

- Collaborating with ASME Standards Committee on Model Credibility, VV50 Subcommittee, Patterns WG created a configurable pattern for representing metadata on any virtual model, including Machine Learning, Simulation (FEA, CFD, SD, ODE), MBSE, otherwise. Auto generates Reqs for models. (ASME WG led by Joe Hightower.)
- This universal metadata framework includes Model Identify and Focus, Model Utility, Model Scope and Content, Model Credibility, Model Representation, and Model Life Cycle Management.
- Those interested in participating can be a part of continued testing and feedback on the application of the MCP to model library organization and management, model exchanges and markets, and model life cycle credibility management.

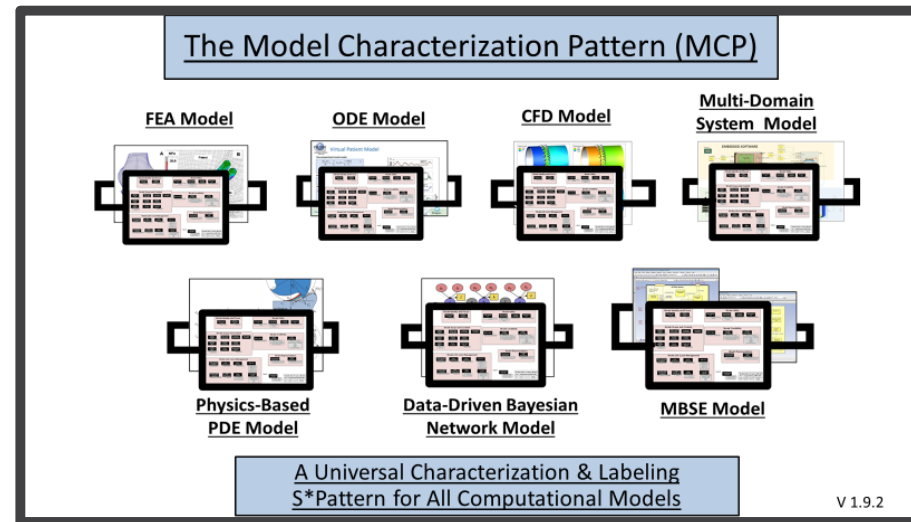

# S\*Pattern Configuration Wizard

- Auto-generates MBSE model in SysML tool, as configuration of Pattern.
- Extendable to any modeling tool.
- Configuration algorithm encodable in any JOIN-supporting environment.
- Configurable patterns for products, enterprise ecosystems, other models.
- Currently in use in ST4SE Project, to be distributed with its deliverables.

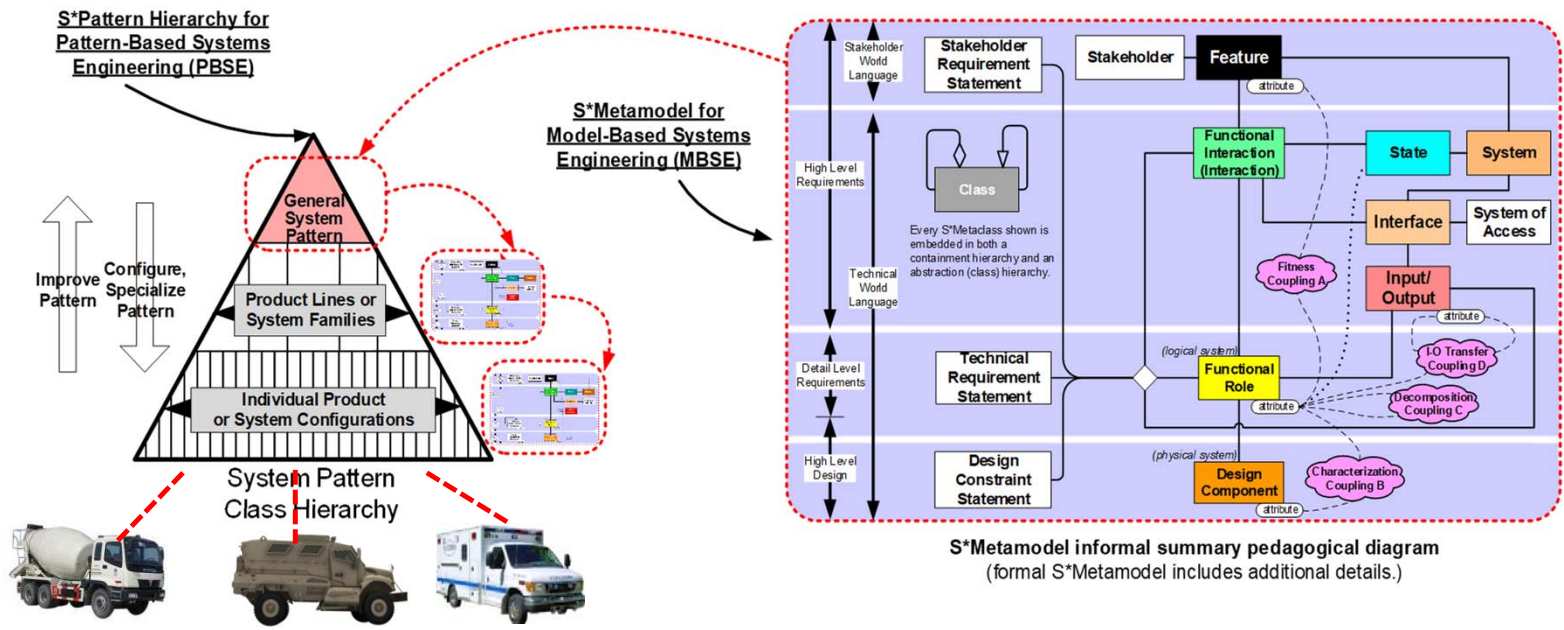

# S\*Pattern Configuration Wizard

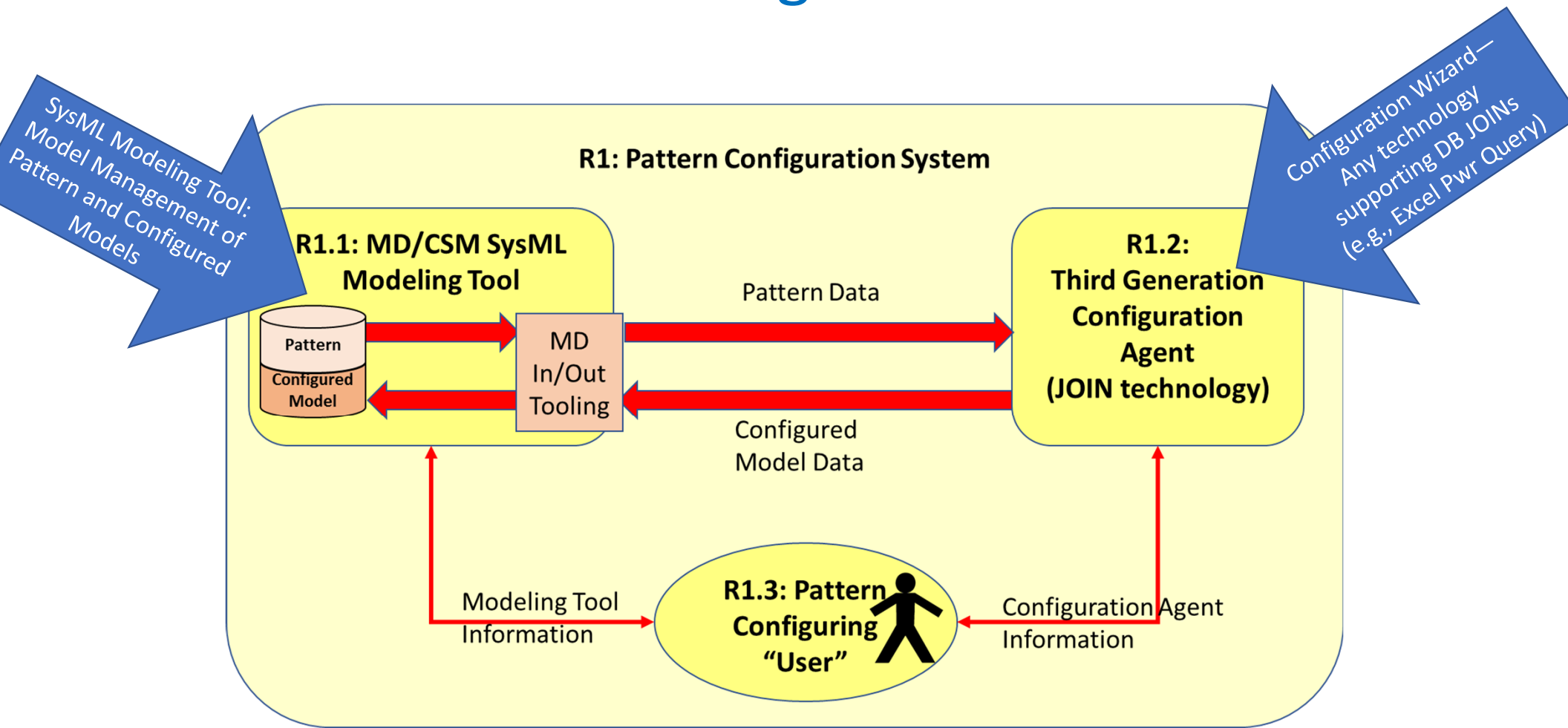

# S\*Pattern Configuration Wizard

## Guide to the S\*Pattern Configuration Wizard

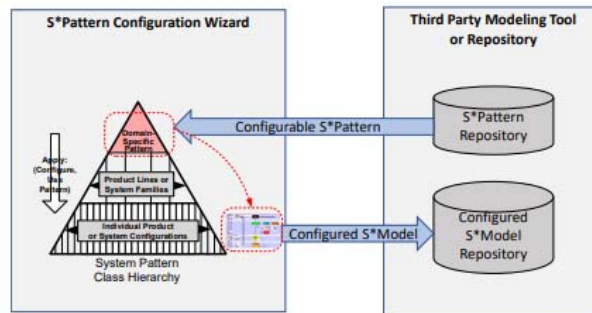

10/27/2022



[https://www.omgwiki.org/MBSE/lib/exe/fetch.php?media=mbse:patterns:guide to the pattern configuration wizard v1.2.8.pdf](https://www.omgwiki.org/MBSE/lib/exe/fetch.php?media=mbse:patterns:guide%20to%20the%20pattern%20configuration%20wizard%20v1.2.8.pdf)





# Minimal S\*Models— A Primer

Startup Project

- Introduction to S\*Metamodel & its mapping to 3rd party COTS modeling tools.
- The laws of nature which are the basis of the natural sciences are all formal descriptions of recurring patterns associated with observable phenomena.
- Finding the smallest model-based representation of those patterns has important practical as well as theoretical importance.
- The practical importance is reduction of unnecessary proliferation of information that is redundant and often inconsistent or conflicting.
- The theoretical importance is that size of minimal models is one of formal measures of (Kolmogorov) complexity.
- Independent of choices of modeling languages, tools, and methods, we want to base our representation of system patterns on the simplest framework necessary for the purposes of engineering and science over the life cycle of systems.
- This Primer is to describe the S\*Metamodel—a long-tested pattern based on the history of physical sciences and engineering, focused on the minimal information set.
- Those interested in participating can be a part of writing and review of this S\*Metamodel Primer—including examples.

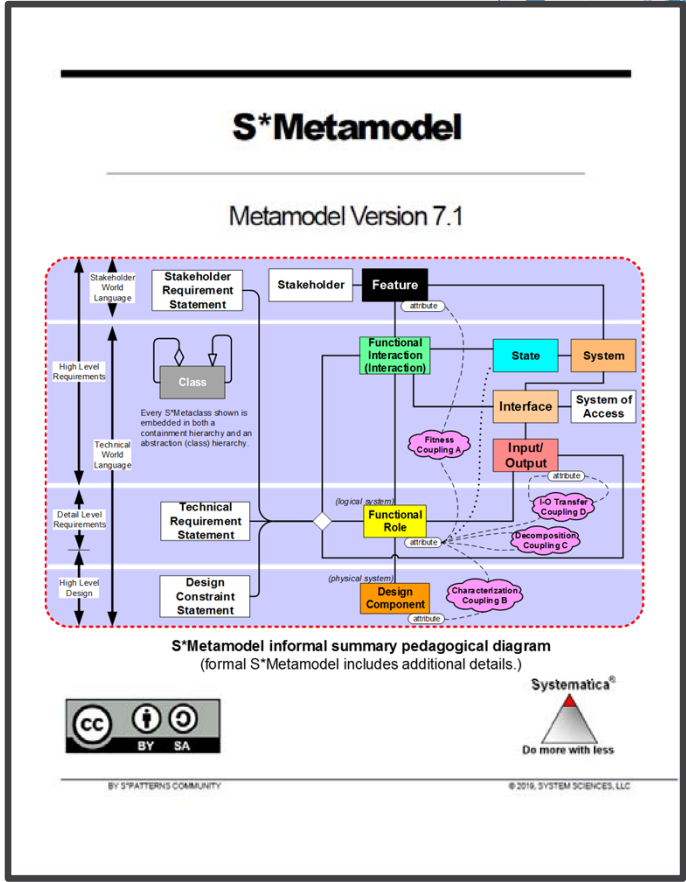

This formal Metamodel Ref is not the Primer.  
[https://www.omgwiki.org/MBSE/lib/exe/fetch.php?media=mbse:patterns:systematica\\_5\\_metamodel\\_v7.1.6a.pdf](https://www.omgwiki.org/MBSE/lib/exe/fetch.php?media=mbse:patterns:systematica_5_metamodel_v7.1.6a.pdf)

# Minimal S\* Models— A Primer

Startup Project

## S\*Models and the S\*Metamodel: A Primer

Decorated Cover

Copyright, Access, and Legends

**In a Nutshell:** What Are S\*Models? What Is the S\*Metamodel? What Problem Do They Solve?

Table of Contents

Table of Figures

- 1 Document Purpose, Scope, Intended Readership
- 2 Motivation of the Need
  - Representing Systems
  - Observed State of Systems Engineering Practice vs. Other Engineering Disciplines
  - Information versus Process versus Automation
  - Strengthening SE Theoretical Foundations: Motivation from the Physical Sciences
    - The System Phenomenon
  - Strengthening SE Practice: Motivation from Current Practice
    - All Behavior in Interaction
    - Functions vs. Interactions
    - Xfer facts
    - Common shortcomings observed in system models
    - 3-way and finding all the \_\_\_
    - FMEA
  - Larger Context Motivations
    - The Value Selection Phenomenon
    - Learning
    - Trust
    - ASELCM
  - Practical Matters: Tooling and Languages
    - Mapping to tools
    - Stronger for use in patterns
    - The INCOSE MBSE Patterns Working Group
- 3 What Is an S\*Model?
  - Definition of S\*Model in terms of S\*Metamodel
  - Agnostic and mapped
  - The Informal Metamodel: Introduction to S\*MetaClasses and S\*Metarelationshps
  - A simple example S\*Model
- 4 What is the S\*Metamodel?
  - The S\*Metamodel reference
  - More S\*MetaClasses and S\*Metarelationshps
- 5 Tooling and Language Mapping
  - S\*Mapping for SysML
  - S\*Profile for CSM
- 6 A Starter Kit for S\*Modelers

7 More Example S\*Model Content

Oil Filter with FMEA etc.

8 References

What is the smallest model of a System?  
S\*Methodology V1.6.1  
Scientific foundations  
Handbook fifth edition  
See also S\*Patterns Primer  
S\*MTM Doc  
Downloadable profile  
S\*Pattern Primer  
SE Handbook 5th edition  
WG web site

- Outline for Primer
- Join this project!
- Good way to learn about MBSE, S\*Models, and the S\*Metamodel.



# S\*Patterns Primer (second edition)

Startup Project

Existing (first) edition

- The Patterns WG generated an introduction and overview of pattern-based methods and their relationships with other subjects—this was several years ago and before the emergence of newer INCOSE Tech Ops approaches to INCOSE Technical Product “primers” on various subjects supported by the working groups.
- This project is concerned with recasting the earlier publication in the form of an updated “Primer” on model-based patterns and related subjects.
- Those interested in participating can be a part of review of the earlier document and newer INCOSE primers, regeneration of an updated primer form asset, or review of the resulting document for submission as a Technical Product.

MBSE Methodology Summary:  
Pattern-Based Systems Engineering (PBSE), Based On S\*MBSE Models

**Document Purpose:**  
This document is a methodology summary for Pattern-Based Systems Engineering using S\*MBSE models. The material below, resulting from Patterns Challenge Team review, feedback, and related updates, is for contribution to the INCOSE-maintained on-line directory “MBSE Methodology: List of Methodologies and Methods”.

The current content of that on-line directory may be found at  
[http://www.omgwiki.org/MBSE/doku.php?id=mbse:methodology#mbse\\_benchmarking\\_survey](http://www.omgwiki.org/MBSE/doku.php?id=mbse:methodology#mbse_benchmarking_survey)

The sectional structure of the following sections conforms to the standard summary outline template used by the referenced methodology directory. The typical methodology descriptions in that directory are currently summaries, not detailed “how to” manuals, for each methodology.

[http://www.omgwiki.org/MBSE/lib/exe/fetch.php?media=mbse:patterns:pbse\\_extension\\_of\\_mbse-methodology\\_summary\\_v1.6.1.pdf](http://www.omgwiki.org/MBSE/lib/exe/fetch.php?media=mbse:patterns:pbse_extension_of_mbse-methodology_summary_v1.6.1.pdf)

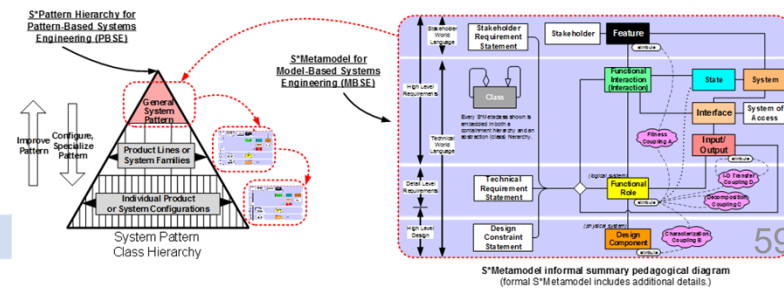

# S\*Patterns Primer (second edition)

Startup Project

- Outline for Second Edition
- Join this project!
- Good way to learn about MBSE Patterns.
- Be a Reviewers or Writer.
- Second Edition—  
Restructures as a Primer



S*Patterns: A Primer	
Decorated Cover	Copyright, Access, and Legends
<b>In a Nutshell:</b> What Are S*Patterns? What Problems Do They Solve?	
Table of Contents	
Table of Figures	
1	Document Purpose, Scope, Intended Readership
2	Requisite Background S*Models and the S*Metamodel
3	Patterns and the History of Science and Engineering Patterns in General S*Patterns Heritage of Patterns in Engineering Heritage of Patterns in Physical Sciences; System Science Goal Architectural Frameworks, Ontologies, Reference Models, Platforms, Families, Product Lines Patterns, Configurations, Compression, Specialization Distillation and Representation of Learning Group Learning and Accessibility Trust in Models; Group Trust Impact on System Life Cycle Processes Applications to Date
4	Using S*Patterns Configuration versus Specialization A Simple Example Creating and Updating S*Patterns
5	Tooling and Language Mapping S*Metamodel Mapping S*Profile for CSM Configuration Wizard Example Using the Configuration Wizard
6	A PBSE Starter Kit
7	More Example S*Pattern Content Oil Filter with FMEA etc.
8	References What is the smallest model of a System? S*Methodology V1.6.1 Scientific foundations Handbook fifth edition See also S*Patterns Primer S*MTM Doc

# ASME Guideline for Managing Credibility of Models for Adv. Manufacturing, w/ASME VV50 Standards Working Grp.

- ASME VV50 Standards-writing project supported by INCOSE began 2016.
- Combining lessons of computational model VVUQ with lessons of MBSE model learning and credibility, supported by model metadata pattern.
- Balloting in 2022.

Verification and Validation Interactions  
with the Model Life Cycle:  
Status of a VV50 Working Group

*Bill Schindel, ICTT System Sciences, [schindel@icctt.com](mailto:schindel@icctt.com)  
on behalf of*

*Joe Hightower, The Boeing Company [joe.c.hightower@boeing.com](mailto:joe.c.hightower@boeing.com), working group chair  
Gordon Shao, NIST, [quodong.shao@nist.gov](mailto:quodong.shao@nist.gov), working group vice-chair*

ASME Virtual Symposium on  
Verification and Validation,  
May 19-20, 2021

[https://www.omgwiki.org/MBSE/lib/exe/fetch.php?media=mbse:patterns:model\\_life\\_cycle\\_working\\_group\\_status\\_v1.2.5.pdf](https://www.omgwiki.org/MBSE/lib/exe/fetch.php?media=mbse:patterns:model_life_cycle_working_group_status_v1.2.5.pdf)

# AIAA Aerospace Digital Twins Case Studies Publication and AIAA Aerospace Digital Thread Position Publication— Supported by INCOSE ASELCM Reference Pattern AIAA-INCOSE Collaboration producing Aerospace Digital Twin and Aerospace Digital Thread reference models, *based on ASELCM Pattern*



<https://www.aiaa.org/resources/digital-twin-implementation-white-paper>

[https://www.omgwiki.org/MBSE/lib/exe/fetch.php?media=mbse:patterns:aiaa-aviation\\_dge-05-report\\_deic\\_digital\\_thread\\_position\\_paper\\_2\\_.pdf](https://www.omgwiki.org/MBSE/lib/exe/fetch.php?media=mbse:patterns:aiaa-aviation_dge-05-report_deic_digital_thread_position_paper_2_.pdf)



## Report on the AIAA DEIC Digital Thread Position Paper

Digital Thread Subcommittee  
Aviation Forum, Chicago, 30 June 2022

Copyright © by American Institute of Aeronautics and Astronautics, Inc  
Published by the American Institute of Aeronautics and Astronautics, Inc., with permission.

# Handbook of System Sciences, for ISSS via Springer-- Chapter: “Patterns in Science and Engineering”, w/ISSS

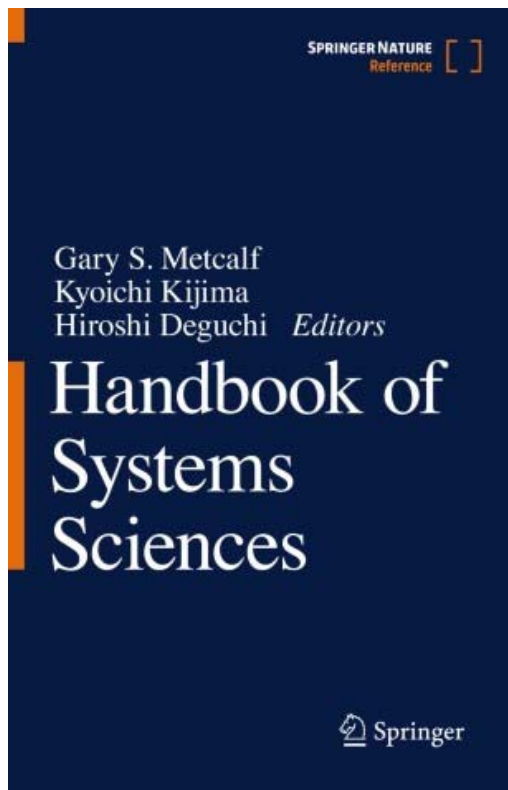

SpringerLink

Handbook of Systems Sciences pp 1-45 | [Cite as](#)

System Patterns in Engineering and Science

Authors Authors and affiliations

William D. Schindel

Living reference work entry  
First Online: 02 September 2020

2 Mentions 186 Downloads

Abstract

Human life is experienced as recurring system patterns – the informal events of everyday living, expression of creativity and aesthetic experiences of the arts, organized observation and discovery in the physical sciences, and technically engineering the systemic improvement of the human condition. Patterns have been expressed and analyzed across these diverse domains in the languages native to each. In the case of science and engineering, the subject of this chapter, explicit formal methods for discovering, synthesizing, representing, analyzing, and applying patterns, have reached great heights, transforming human life over three centuries. In spite of successes, diversity of language and perspective across individual physical science and engineering disciplines has masked the common thread of system patterns running through these scientific and engineering works. The more recent attention to the science and engineering of systems in general, including explicit models of general systems, illuminates the nature of general system patterns and their fundamental contribution to representation and progress in science and engineering of systems. In addition to providing a unifying perspective to historical accomplishments of specialized disciplines, system patterns also simplify the complexity of existing engineering environments while advancing ability to develop new scientific and engineering disciplines for more complex domains, including markets, networks, distribution systems, the Internet of Things, communities, and the innovation process itself. This chapter and references provide an actionable perspective for readers interested in this revolution. A key lesson of this chapter is that system patterns reduce the challenge of accomplishing nearly any goal in the life of systems.

- ISSS Reference Textbook project supported by Patterns Working Group.
- Chapter on “System Patterns in Engineering and Science”
- An ISSS-INCOSE effort.

# Handbook of Model-Based Systems Engineering, Madni & Augustine, eds, Springer, Chapter: “MBSE Patterns”.



- Generation of “Pattern-Based Methods and MBSE” chapter for new *Handbook of Model-Based Systems Engineering*.
- Editors: A. Madni and N. Augustine.

1 Pattern-Based Methods and MBSE AU1  
AU2

Proof copy in production

3 **Contents**

4	Introduction .....	2
5	MBSE Pattern Concept .....	2
6	Expanded Perspective and Organization of Chapter .....	3
7	State-of-the-Art .....	4
8	The Most Important Pattern: What Is the Smallest Model of a System? .....	4
9	Introduction to the S*Metamodel .....	6
10	S*Models and S*Patterns .....	12
11	Distillation and Representation of Learning, Accessibility and Impact of Learning .....	15
12	Tooling and Language Issues for MBSE Patterns .....	17
13	Best Practice Approach .....	23
14	INCOSE Innovation Ecosystem Reference Pattern .....	23
15	Model Characterization Pattern: Universal Model Metadata Reference Pattern .....	27
16	Illustrative Examples .....	32
17	Chapter Summary .....	33
18	Impact on Practice, Education, and Research .....	33
19	Impact on the Theoretical Foundations of Systems Engineering .....	37
20	References .....	41

21 **Abstract**

22 Patterns are recurring regularities, having fixed and variable parts, across  
23 engineered systems, systems of engineering, production, distribution, and  
24 sustainment, as well as the natural world. Ranging from concrete patterns of  
25 engineered product lines to abstract patterns behind architectural frameworks,  
26 reference models, ontologies, and general or domain-specific languages, patterns  
27 are implicitly involved in all MBSE practice. Methods reported in this chapter  
28 exploit the power of explicit MBSE patterns, using the leverage of acquired  
29 knowledge to speed processes, reduce rediscovery and error, and lower risk.

W. D. Schindel (✉)  
AU3 ICTT System Sciences, Terre Haute, IN, USA  
e-mail: schindel@ictt.com

© Springer Nature Switzerland AG 2022  
A. Madni et al. (eds.), *Handbook of Model-Based Systems Engineering*,  
[https://doi.org/10.1007/978-3-030-27486-3\\_73-1](https://doi.org/10.1007/978-3-030-27486-3_73-1)

64 1



## INCOSE SE Handbook, 5th Ed., for INCOSE, D. Contributed invited material on ASELCM Pattern, Pattern-Based Methods, and S\*Metamodel

- The Patterns Working Group is contributing invited content on pattern-based methods to the INCOSE SE Handbook, 5<sup>th</sup> edition project, now in generation.
- The structure of the 5<sup>th</sup> Edition of the SE Handbook is re-architected compared to past editions, based on progress and needs of the community.
- Now in the final publication process.
- Overall project is led by INCOSE Handbook Editorial Team, chaired by Dave Walden.

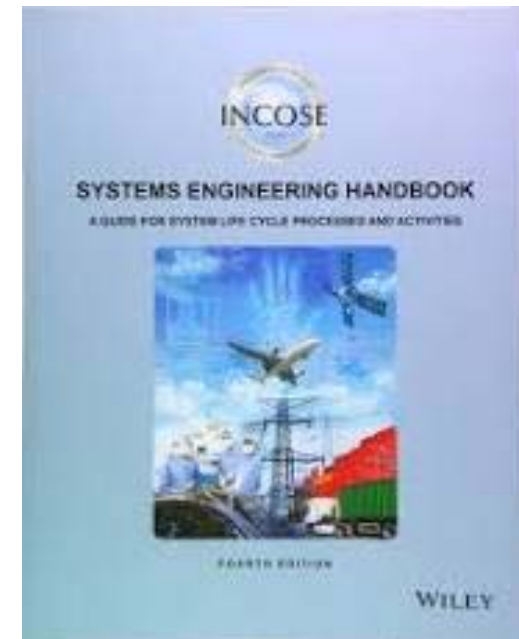

**Current (4<sup>th</sup>)  
Edition**

# INCOSE Vision 2035 contributions, from WG's SE Theoretical Foundations Project

- The Patterns Working Group provided invited content on SE Theoretical Foundations for the *INCOSE Vision 2035* publication project, completed for IW2022.
- Publication project led by editorial team chaired by S. Friedenthal.
- Material drawn from the ongoing SE Theoretical Foundations Project of the Patterns Working Group.
- Participating in IW2023 FuSE streams

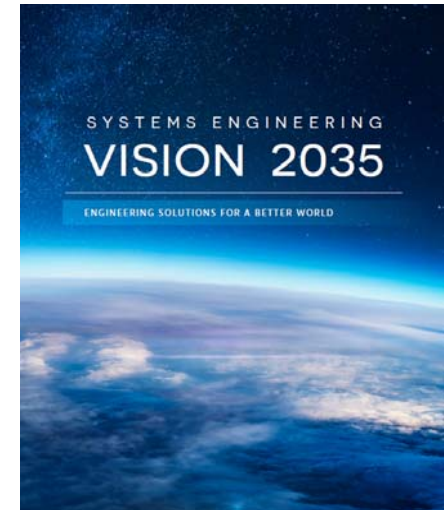

[http://www.omgwiki.org/MBSE/lib/exe/fetch.php?media=mbse:patterns:science\\_math\\_foundations\\_for\\_systems\\_and\\_systems\\_engineering--1\\_hr\\_awareness\\_v2.3.2a.pdf](http://www.omgwiki.org/MBSE/lib/exe/fetch.php?media=mbse:patterns:science_math_foundations_for_systems_and_systems_engineering--1_hr_awareness_v2.3.2a.pdf)

Bill Schindel, ICTT System Sciences, [schindel@icct.com](mailto:schindel@icct.com)  
V2.3.2



**INCOSE**

Implications for Future SE Practice, Education, Research:  
**SE Foundation Elements**

Discussion Inputs to *INCOSE Vision 2035* Theoretical Foundations Section

---

(awareness version, 1 hour) Copyright © 2020 by W. D. Schindel. Permission granted to INCOSE to publish and use.



# INCOSE INSIGHT, Digital Engineering Issue, March, 2022

F. Salvatore and T. Gilbert, special issue editors

## INSIGHT

This Issue's Feature:  
**Digital Engineering**

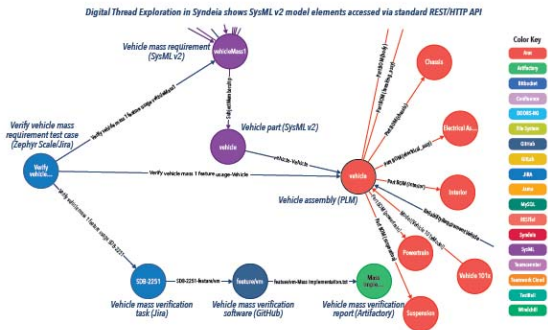

Illustration credit: From the article 'System Modeling Language (SysML v2) Support for Digital Engineering' by Riccardo, Sander Fritenthal, and Stefano. See page 18

MARCH 2022  
VOLUME 25 / ISSUE 1



A PUBLICATION OF THE INTERNATIONAL COUNCIL ON SYSTEMS ENGINEERING

SPECIAL  
FEATURE

MARCH 2022  
VOLUME 25 / ISSUE 1

# Realizing the Value Promise of Digital Engineering: Planning, Implementing, and Evolving the Ecosystem

William D. Schindel, [schindel@icctt.com](mailto:schindel@icctt.com)

Copyright © 2022 by William D. Schindel. Published by INCOSE with permission.

**ABSTRACT**

Gaining the benefits of Digital Engineering is not only about implementing digital technologies. The Innovation Ecosystem is a system of systems in its own right, at least partly engineered, subject to the risks and challenges of evolving socio-technical systems. This article summarizes an aid to analyzing and understanding, planning, implementation, and ongoing improvement of the Innovation Ecosystem or its components. It is based on a generic ecosystem analysis reference model with particular focal viewpoints. It is represented as a configurable model-based formal pattern and the INCOSE MBSE Patterns Working Group initially applied it in a related INCOSE collaboration project led by the Agile Systems Engineering Working Group. Users of the resulting framework subsequently elaborated and applied aspects in the context of a wide variety of commercial and defense ecosystems across different domains. While connecting to several current and historical contexts, it is particularly revealing of Digital Engineering's special promise. By explicating the recurrent theme of Consistency Management that underlies all historical innovation, it enhances our understanding of historical as well as future engineering and life cycle management. This includes

## Discussion of additional and future interests of attendees

- 
- 
- 
- 
- 
- 
-

# References (see also links embedded in previous pages)

1. “SE Foundation Elements: Implications for Future SE Practice, Education, Research”. Retrieve from--  
[http://www.omgwiki.org/MBSE/lib/exe/fetch.php?media=mbse:patterns:science\\_math\\_foundations\\_for\\_systems\\_and\\_systems\\_engineering--1\\_hr\\_awareness\\_v2.3.2a.pdf](http://www.omgwiki.org/MBSE/lib/exe/fetch.php?media=mbse:patterns:science_math_foundations_for_systems_and_systems_engineering--1_hr_awareness_v2.3.2a.pdf)
2. “The Model Characterization Pattern (MCP): A Universal Characterization & Labeling S\*Pattern for All Computational Models”. Retrieve from --  
[http://www.omgwiki.org/MBSE/lib/exe/fetch.php?media=mbse:patterns:model\\_characterization\\_pattern\\_mcp\\_v1.9.3.pdf](http://www.omgwiki.org/MBSE/lib/exe/fetch.php?media=mbse:patterns:model_characterization_pattern_mcp_v1.9.3.pdf)
3. “Introduction to the Agile Systems Engineering Life Cycle MBSE Pattern”. Retrieve from --  
[http://www.omgwiki.org/MBSE/lib/exe/fetch.php?media=mbse:patterns:is2016\\_intro\\_to\\_the\\_aselcm\\_pattern\\_v1.4.8.pdf](http://www.omgwiki.org/MBSE/lib/exe/fetch.php?media=mbse:patterns:is2016_intro_to_the_aselcm_pattern_v1.4.8.pdf)
4. “Consistency Management as an Integrating Paradigm for Digital Life Cycle Management with Learning:”  
[http://www.omgwiki.org/MBSE/lib/exe/fetch.php?media=mbse:patterns:aselcm\\_pattern\\_--consistency\\_management\\_as\\_a\\_digital\\_life\\_cycle\\_management\\_paradigm\\_v1.2.2.pdf](http://www.omgwiki.org/MBSE/lib/exe/fetch.php?media=mbse:patterns:aselcm_pattern_--consistency_management_as_a_digital_life_cycle_management_paradigm_v1.2.2.pdf)
5. “INCOSE Semantic Technologies for Systems Engineering (ST4SE): Deliverables Technical Product Plan (TPP)”. Retrieve from--  
[http://www.omgwiki.org/MBSE/lib/exe/fetch.php?media=mbse:patterns:incose\\_patterns\\_wg\\_st4se\\_project\\_tpp\\_v2.0\\_signed.pdf](http://www.omgwiki.org/MBSE/lib/exe/fetch.php?media=mbse:patterns:incose_patterns_wg_st4se_project_tpp_v2.0_signed.pdf)
6. “MBSE Methodology Summary: Pattern-Based Systems Engineering (PBSE), Based on S\*MBSE Models”. Retrieve from --  
[http://www.omgwiki.org/MBSE/lib/exe/fetch.php?media=mbse:patterns:pbse\\_extension\\_of\\_mbse--methodology\\_summary\\_v1.6.1.pdf](http://www.omgwiki.org/MBSE/lib/exe/fetch.php?media=mbse:patterns:pbse_extension_of_mbse--methodology_summary_v1.6.1.pdf)
7. “What Is the Smallest Model of a System?” Retrieve from --  
[http://www.omgwiki.org/MBSE/lib/exe/fetch.php?media=mbse:patterns:what\\_is\\_the\\_smallest\\_model\\_of\\_a\\_system\\_v1.4.4.pdf](http://www.omgwiki.org/MBSE/lib/exe/fetch.php?media=mbse:patterns:what_is_the_smallest_model_of_a_system_v1.4.4.pdf)
8. MBSE Patterns Working Group web sites:
  - Public-facing (main resources, INCOSE joint with OMG): <http://www.omgwiki.org/MBSE/doku.php?id=mbse:patterns:patterns>
  - Inward-facing (incose.org): <https://www.incose.org/incose-member-resources/working-groups/transformational/mbse-patterns>



**2023**  
Annual **INCOSE**  
international workshop  
**HYBRID EVENT**  
Torrance, CA, USA  
January 28 - 31, 2023

[www.incose.org/IW2023](http://www.incose.org/IW2023)